

Rural Builder®

SOURCE BOOK

seven

August 2015 • Volume 49, Issue 5



Cutting-edge ideas to inspire your
next **construction innovations**



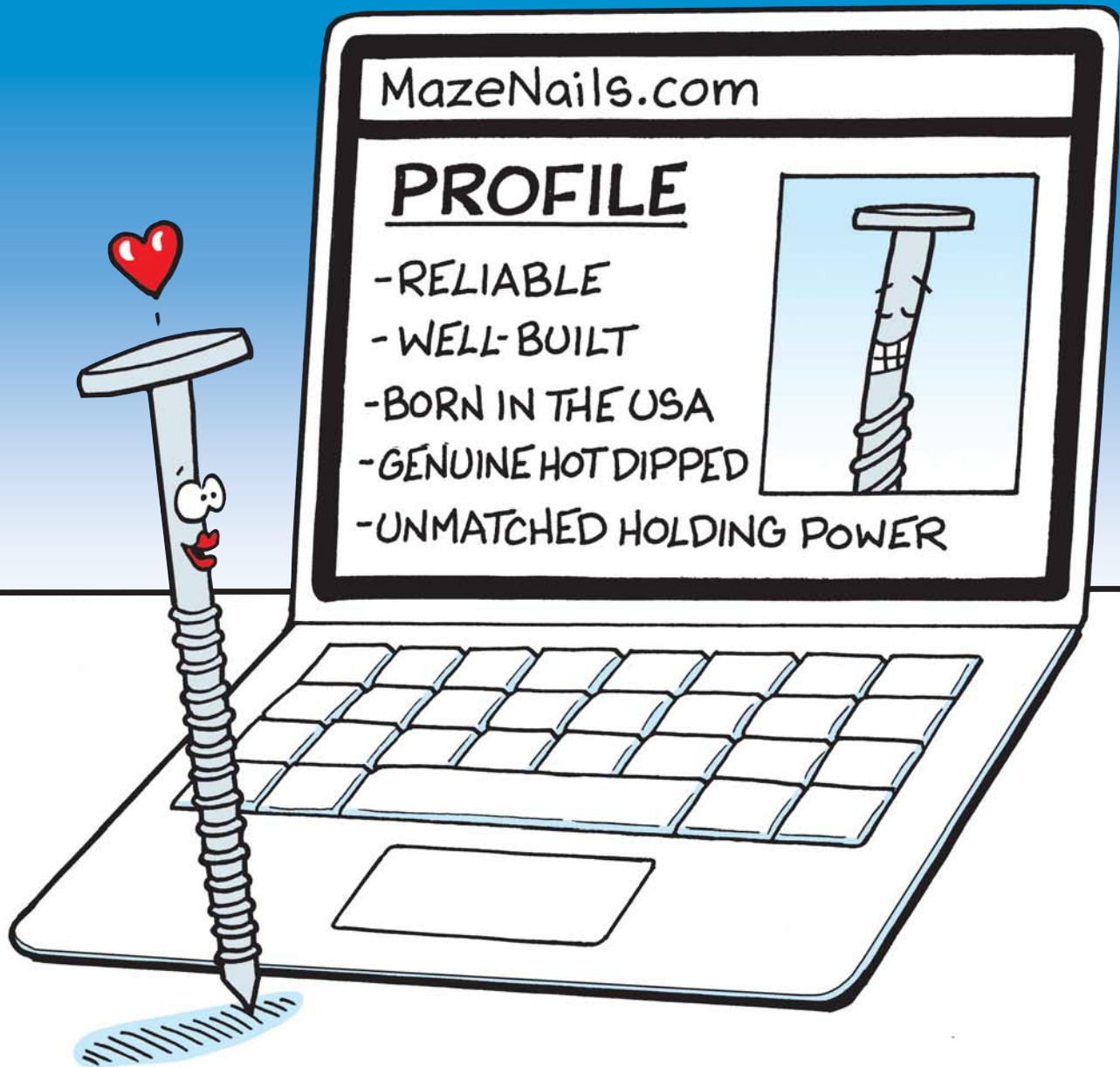

**CALL US FOR MORE
INFORMATION AND
WE'LL FIND YOU
THE PERFECT MATCH!
800-435-5949**

Rural Builder® SOURCE BOOK seven

Volume 49, Issue 5

Vice President/Group Publisher
Jamie Wilkinson

Publisher/VP Advertising Sales
Dave Davel

Editorial Director
Debbie Bradley

Editor
Sharon Thatcher - sharon.thatcher@fwcommunity.com
715-445-2214, ext. 13644

Advertising Sales
Gary Reichert - gary.reichert@fwcommunity.com
715-445-2214, ext. 13381

Publication Design
Nicole MacMartin

Production Coordinators
Kathy Budsberg - kathy.budsberg@fwcommunity.com
715-445-2214, ext. 13309

Patti Kirchner - patti.kirchner@fwcommunity.com
715-445-2214, ext. 13319

Subscription Services
386-246-3452

Office Phone
715-445-2214

Office Fax
715-445-4087

F+W, A CONTENT + ECOMMERCE COMPANY

Chairman & CEO
David Nussbaum

CFO & COO
Jim Ogle

President
Sara Domville

CDO
Chad Phelps

SVP, Mfg. & Production
Phil Graham

VP, Communications
Stacie Berger

SUBSCRIPTION SERVICE

Subscription inquiries, orders and address changes can be made at constructionmag-net.com (click on "Subscribe"). Or by mail: Rural Builder, P.O. Box 421751, Palm Coast, FL 32142-1751. Or call (866)805-1574, International (386)246-3452

Rural Builder (ISSN: 0888-3025) Volume 48 Number 5 is published monthly, except January, April, June and November, by Krause Publications, a division of F+W Media, Inc., 700 E. State Street, Iola, WI 54990-0001. Periodical postage paid at Iola, WI, and at additional mailing offices. Canadian Agreement Number: 40666675. POSTMASTER: send address changes to Rural Builder, Circulation Department, PO Box 420235, Palm Coast, FL 32142. Copyright 2014 by F+W Rural Builder and its logo are registered trademarks. Other names and logos referred to or displayed in editorial or advertising content may be trademarked or copyright. Rural Builder assumes no responsibility for unsolicited materials sent to it. Publisher and advertisers are not liable for typographical errors that may appear in prices or descriptions in advertisements. Mailed free to rural contractors and their suppliers throughout North America. Others may subscribe: \$29.98 for 1 year, \$55.98 for 2 years, and \$79.98 for 3 years in the U.S.; \$39.98 for 1 year, \$74.98 for 2 years in Canada.



Structural Insulated Panel Association

TABLE OF CONTENTS

PROJECTS

- | | |
|--|---|
| 4 COMMERCIAL OFFICE & SHOP
<i>from Graber Post Buildings</i> | 15 COMPANY HEADQUARTERS
<i>from Metallic Building Company</i> |
| 6 RESIDENTIAL SHOP & "MAN CAVE"
<i>from Wick Buildings</i> | 16 SPACE ROCKET HANGAR
<i>from Schweiss Doors</i> |
| 8 SPORTS COMPLEX
<i>from Quality Structures Inc.</i> | 18 MAINTENANCE SHOP
<i>from Amarr</i> |
| 10 PRIVATE RESIDENCE
<i>from Valspar</i> | 20 WAREHOUSE
<i>from Armstrong Steel Buildings</i> |
| 12 AG STORAGE & SHOP
<i>from Hydroswing</i> | 21 FEED STORE
<i>from Replications Unlimited</i> |
| 13 WINERY
<i>from Varco Pruden</i> | 58 AUTOMOTIVE DETAILING SHOP
<i>from Levi's Building Components</i> |
| 14 RESIDENTIAL GARAGE
<i>from PowerLift Hydraulic Doors</i> | |

PRODUCTS

- | | |
|---|--|
| 22 POST FRAME & METAL BUILDING SYSTEMS | 38 RETROFIT |
| 23 NAILS & SCREWS | 40 COIL |
| 26 DOORS | 40 CUPOLAS |
| 28 DOOR HARDWARE | 44 PAINT & COATINGS |
| 29 WINDOWS | 45 RECOATINGS |
| 30 SKYLIGHTS & DAYLIGHTING | 46 ADHESIVES, SEALANTS & CAULKS |
| 31 ROOF & WALL PANEL | 49 INSULATION |
| 34 INTERIOR WALL PANEL | 50 VENTILATION |
| 34 ROOF CLAMPS | 52 MOISTURE & VAPOR BARRIERS |
| 36 SNOW MANAGEMENT | 52 TRUSSES & COLUMNS |
| 38 WIND UPLIFT CONTROL | 53 FOUNDATION PRODUCTS |
| 38 UNDERLAYMENT | 54 EQUIPMENT |
-
- | | |
|--------------------|--------------------------|
| 42 AD INDEX | 57 CLASSIFIED ADS |
|--------------------|--------------------------|

Welcome to the SOURCE BOOK seven

For readers not familiar with the annual *Rural Builder Source Book* we use the issue to give our audience of builders and designers some products and projects to consider. Some of the project features are intriguing and inspiring, while others are simple but solid. We also offer a list of popular products that are noteworthy in the metal and post-frame industries. We hope you can take some time out of your busy day to browse through these pages. Keep it on your desk for future reference. Use the information provided to help further your own efforts to build good and to build strong.

- The Editors

Cover photos courtesy of: (top to bottom) Wick Buildings, Valspar, Replications Unlimited and Varco Pruden. Design by Nicole MacMartin.



COMMERCIAL OFFICE & SHOP

Graber Post Buildings

www.graberpost.com



When Boyd and Company approached Graber Post about a new facility in Washington, Indiana, Graber was excited for an opportunity to construct something that highlights some of the untapped potential of post-frame construction. Post frame allowed Boyd—a diversified heavy construction company—to



have a building that meets and/or exceeds their needs, while being very cost effective per square foot. Parapet walls on the office building added a commercial appeal, but created a challenging roof system. A unique feature in the shop portion of the building is the stepped ceiling which allows for the future addition of an overhead crane without sacrificing ceiling height.

► For more product information from **GRABER POST BUILDINGS**, see page 22.

LOCATION:

*Boyd and Company
U.S. headquarters,
Washington, Indiana*

SIZE:

*Shop: 100'x342'x20'
Office: 80'x80', 2-story with
full basement*

EXTERIOR PANEL:

*#1 G-rib metal roofing and siding
Brick veneer on office portion*

GENERAL CONTRACTOR:

Boyd and Company Construction

BUILDING SYSTEM:

*Graber Post Buildings
Post frame*

INSULATION:

*R-38 blown fiberglass attic insulation
R-19 batt insulation in walls*



Strength in all Seasons

Since 1951, Plyco has stood by you and by their products. Plyco offers a complete line of entry doors that surpass building codes and customer expectations. At Plyco, we've become the leader by delivering the quality products you and your customers demand.

Build Plyco Strong.



PLYCO
CORPORATION

800.558.5895 • Fax: 800.257.5926 • www.plyco.com • Elkhart Lake, Wis.

Circle Reader Service #313



RESIDENTIAL SHOP & “MAN CAVE”

Wick Buildings
www.wickbuildings.com

•••

This combination cold storage, workshop and “man cave” sits on the site of an old dairy barn. The customer kept the silo, refurbished it and actually incorporated it as an attached room and “look out”.

► For more product information from **WICK BUILDINGS**, see page 22.

LOCATION:

Minnesota

BUILDER:

Todd Norton Construction,
Waseca, Minnesota

SIZE:

51'x104'x15'

BUILDING SYSTEM:

Wick Buildings
post frame

EXTERIOR PANEL:

Wick steel in
burnished slate
and beige

FEATURES:

Two 36" cupolas
One 48" cupola

The **Wrinkled** Series

The One Time You'll Actually WANT Wrinkles!

Want a distinguished look from every angle? Everlast Roofing can help! We are introducing a new paint finish that not only protects, it dignifies.

The *Wrinkled Series* provides you a textured paint finish that is available in Everlast's most popular profiles, making this finish an excellent choice for residential and commercial application. Request this series on top of our already proven Everlast II and Everloc panels to create a surface that is tough, scratch resistant and distinct.

Advantages Include:

- Low gloss finish
- High durability SMP
- 8 standard in-stock colors
- 40 year warranty

When you want to add character to an old or new roof ask for Wrinkles. The Wrinkled Series by Everlast Roofing Inc., Our Name Says It All!



Toll Free: 888.339.0059
www.everlastroofing.com

LOCATION:

*Humbolt School District
Humbolt, Kansas*

BUILDER:

Quality Structures Inc.

BUILDING SYSTEM:

Post frame

SIZE:

*Sports complex:
56'X162'X10'; Press box
built atop football stadium
bleachers: 8'X36'X19'*

ENGINEER:

Halberg Engineering LLC

WALL AND ROOF PANEL:

*36" Imperial Rib 29 gauge
from American Building
Components*

INSULATION:

*WeatherWrap Micro-Foil
insulation from NOFP.
R-19 batt insulation.*

VENTILATION:

*24" boxed overhangs with
vented soffit from American
Building Components*

FASTENERS:

*HWH Ultra Z screws
with washer from Atlas
Bolt & Screw. Complex
building and press box
posts fastened with
Midwest Perma Column
SW Brackets and Titan HD
6" anchors from Simpson
Strong-Tie*

FINISH DETAILS:

*Sports complex has 4 foot
cut-stone wainscot*



SPORTS COMPLEX

Quality Structures Inc.

www.qualitystructures.com



The Humbolt School District was looking for an updated sports complex that could facilitate any sporting event. Their goal was to give their student athletes, students, faculty and families the best athletic experience in the region. The curved steel trusses on the press box, built by Genco Manufacturing Inc., is the focal point of the structure as it overlooks a sprawling sports complex from 40 feet in the air. The Sports complex building itself features a 16 foot inset porch. The concession area has two 8x6 foot roll-up doors and the interior of the building features a 29 gauge steel ceiling liner by American Building Components.

THANK YOU CANNONBALL CUSTOMERS

FOR OUR BIGGEST PRODUCT LAUNCH EVER!

NOW LET'S OPEN SOME DOORS TOGETHER...

CANNONBALL

**1900-SERIES
ENTRY DOORS**

As seen at:
NFBA
FRAME BUILDING
EXPO
Louisville, KY

- Professional looks and field adaptability for any building project
- 24-gauge steel skin, 16-gauge steel jamb and Grade 40 security
- Wide variety of panel embossment options

Recommended Use

<input checked="" type="checkbox"/>	Agriculture
<input checked="" type="checkbox"/>	Commercial
<input checked="" type="checkbox"/>	Metal

Open FOR BUSINESS!

OUR NEWEST, MOST VERSATILE DOOR IS NOW AVAILABLE!

800-766-2825 • Beloit, WI
www.cnbhnp.com

CANNONBALL

Please provide this coupon and a cut-out 1920-model box label to the address listed below for redemption of rebate amount.

\$50 RETAIL REBATE*

Continental U.S. & Canada Only.
Program Dates: 07/01/15 – 08/31/15.
Redemption Expiration: 10/01/15.



1920 Steel Entry Door

- 24-gauge steel panel / 16-gauge steel jamb
- 3068 Call Size (40" x 81-5/16" out-to-out)
- White plain panel with universal swing (embossment options available)

**MAIL THIS COUPON & A CUT-OUT 1920 BOX LABEL
TO THE FOLLOWING ADDRESS FOR REBATE REMPTION:**

**CannonBall Retail Rebate
555 Lawton Ave. | Beloit, WI 53512**



2015

* = Not redeemable for cash or credit. Not valid as a discount on original 1920 Entry Door purchase. Rebate amount paid via Visa gift card. Limit one rebate per customer mailing address.

800-766-2825 • Beloit, WI
www.cnbhnp.com



Circle Reader Service #386

LOCATION:

*Ilhan & Kamer Eser
residence, Woodland,
California*

GENERAL CONTRACTOR:

Ilhan Eser

ROOF & WALL PANEL:

*R-42 Kingspan insulated
panels from MORIN, a
Kingspan Company Group*

PANEL INSTALLATION:

*Rua and Sons Mechanics
Inc., Lincoln, California*

PANEL COATINGS:

*Exterior walls: Valspar
Kameleon Colors in
Dusty Rose applied in a
three-coat system with
primer, base coat and
color coat to match the
countryside setting; Roof:
Valspar Fluoropon coating
in Surrey Beige for solar
reflectivity*

SOLAR POWER SYSTEMS:

*SolarEdge from Gimenz
Electric, Woodland, California*

**ENGINEERED
SEPTIC SYSTEM:**

*A.P. Plumbing & Fire,
Woodland, California*

**GEOTHERMAL
HEATING AND COOLING:**

*Hydron Module from
Sierra Eco Systems,
Genoa, Nevada*

**FIRE-RESISTANT
ACOUSTIC INSTALLATION:**

*Roxul Safe 'n' Sound from
Auburn Acoustic Systems,
Auburn, California*



PRIVATE RESIDENCE

Valspar

www.valsparcoilextrusion.com



“When people think ‘metal’ they think of agricultural silos or warehouses,” said homeowner Ilhan Eser. But as CEO of MORIN, a Kingspan Group Company, he recognized that the new home, for he and his wife Kamer, offered an interesting opportunity. It would utilize his company’s insulated metal panels in an unconventional way. Added to the mix was exterior Kameleon Color coatings from Valspar. The pearlescent paints appear to shift in color based on the lighting or viewing angle. People deliberately take a side trip to the house to watch the color change as the lighting angle changes.

“It’s very, very unique,” said Ilhan, “and everybody’s first impression is, ‘Wow, how did you guys do that?’”



► For more product information from VALSPAR, see page 45.

Cool color.
Cool impressions.
Cool savings.



Save energy costs with cool protective coatings that create a colorful, lasting impression. With the highest solar reflective (SR) pigments in the industry, Valspar decreases environmental impact by increasing energy efficiency. Lower energy costs without sacrificing durability, performance or beauty. Call 1-888-306-2645 to speak with an expert, or visit us at valsparcoilextrusion.com/greenagenda.

valspar



AG STORAGE & SHOP

Hydroswing

www.hydroswing-agdoors.com



LOCATION:

Midwest

SIZE:

150' length

DOORS:

One 25'x18', One 15'x18'
from Hydroswing
Hydraulic Doors

The building owners needed double hydraulic doors to accommodate multiple tractors and equipment. The agricultural specialty doors allow for maximum opening when farm chores shift to maintenance projects in the shop. For security, it is impossible to operate without access to the control unit and can be operated during a power outage by using a generator. The zero drop two-way Hydrolok system also assures that the doors will never fall should there be a loss of power. The owners requested cladding and windows to make the building match the remainder of the property.



► For more product information from **HYDROSWING**, see page 26.



ECO-FRIENDLY PRODUCTS

Manufacturer of Over 100 Environmentally Safe Insulating Ceramic Waterproofing Paints and Coatings



www.nationwidecoatings.com



RESIDENTIAL - COMMERCIAL - INDUSTRIAL

<p>INTERIOR CERAMIC PAINTS</p> 	<p>EXTERIOR CERAMIC PAINTS</p> 	<p>ELASTOMERIC WALL COATINGS</p> 	<p>PROTECTIVE WOOD & DECK FINISH</p> 	<p>CLEAR ACRYLIC ROOF COATINGS</p> 	<p>ELASTOMERIC ROOF COATINGS</p> 
--	---	---	---	--	---

ELASTOMERIC WATERPROOFING INSULATING CERAMIC ROOF COATINGS - ZERO V.O.C. INSULATING CERAMIC INTERIOR & EXTERIOR PAINTS
ELASTOMERIC CERAMIC WALL, TEXTURE & INDUSTRIAL COATINGS - CONCRETE & DECK PAINTS, STAINS, CLEAR COATS & SEALERS
WOOD STAINS, CLEARS & DECK-OVER COATINGS - EPOXIES - COLOR MATCHING & CUSTOM FORMULATIONS

CALL TODAY FOR FREE SALES & MARKETING BOOK!



NATIONWIDE PROTECTIVE COATING MANUFACTURERS, INC.

SARASOTA - FLORIDA - USA



The PERMANENT Coating Solution™

1.800.423.7264  941.753.7500

Circle Reader Service #463

WINERY

Varco Pruden Buildings

www.vp.com



Burntshirt Vineyards is an 80 year old estate vineyard located at Hendersonville, North Carolina. It features 25 acres of grapes at vineyards among the highest elevations in North Carolina and the eastern seaboard. The Varco Pruden building is used for the manufacturing of Burntshirt wines. The



project garnered Cooper Construction Company a Best of Category designation for agricultural construction in the 2015 Hall of Fame awards presented by Varco Pruden.

► For more product information from **VARCO PRUDEN BUILDINGS**, see page 23.



LOCATION:

*Burntshirt Vineyards,
Hendersonville,
North Carolina*

PROJECT DESIGNER:

*Thomas R. Wilson
Engineering, Asheville,
North Carolina*

BUILDER:

*Cooper Construction
Company Inc., Flat
Rock, North Carolina*

SIZE:

10,500 square feet

EXTERIOR PANELS:

*Panel Rib from Varco Pruden
Buildings for roof and walls*



RESIDENTIAL GARAGE

PowerLift Hydraulic Doors

www.powerliftdoors.com



This garage is part of an oceanfront estate on Puget Sound in Washington. The owners had their builder create a garage that resembles a home to complement other structures on the property. The PowerLift opening wall is finished and

trimmed so there is no visible opening when in the closed position.

This PowerLift wall opens fully in about 40 seconds to access storage space for a Class A motorhome, Jeep, ATV and other vehicles.



► For more product information from POWERLIFT, see page 27.

LOCATION:

Puget Sound, Washington

BUILDER:

Ken Howlett

DOOR:

16'x16' from PowerLift Hydraulic Doors

We can take any ribbing
and make light of it.



Match virtually any custom profile with SunSky in days.

Get the leading corrugated polycarbonate delivered fast to fit most any metal profile with SunSky® MetalMatch™ technology. So you can add value and more daylight to projects in as little as two weeks. And MetalMatch is available at an extremely attractive price.



More daylighting options. More easily.

SunSky's first-in-class durability, high performance and superior light transmission are ideal for roof, side and skylight applications. So you can expand unique design possibilities, reduce energy costs, and enhance environments with more natural light. Available in several opacities,



including Soft White, SunSky is backed by a 10-year warranty. To learn more, contact your local distributor or call **800-999-9459**. Or visit us at www.PalramAmericas.com/MyProfile. We'll take the perfect ribbing and make it even better.



Circle Reader Service #350



OFFICE BUILDING

Metallic Building Company

www.metallic.com



This remarkable building, recognized as Metallic Building Company's 2014 Building of the Year, includes a café, covered deck, fitness center and a stunning lobby with 52 foot high ceilings. The roof systems used in this project, the low-e windows and the masonry wall finish covering the building's metal frame are key elements in creating the natural look and feel that Melton Truck Lines was striving for.

► For more product information from **METALLIC BUILDING COMPANY**, see page 22.

LOCATION:

*Melton Truck Lines
world headquarters,
Tulsa, Oklahoma*

BUILDER:

*Ram Jr LLC,
Catoosa, Oklahoma*

SIZE:

75,000 square feet

BUILDING SYSTEM:

*Metal building from
Metallic Building Company,
Houston, Texas*

ROOF SYSTEMS:

*BattenLok and
DoubleLok*



SPACE ROCKET HANGAR

Schweiss Doors

www.bifold.com



This is not your typical hangar and these are not your typical doors. Schweiss Doors, which specializes in large custom-made doors for everything from conventional aircraft hangars to agricultural buildings, has latched onto several projects for SpaceX, a company on the forefront of space exploration. Their latest order was for two mega-doors destined for a new steel hangar at Cape Canaveral. Each door is equipped with automatic latches that are wind rated to 150 mph. After arriving at the site, they were clad in 26 gauge sheeting and 4-inch blanket insulation. Bottom drive 480 volt, 3-phase motors and patented liftstraps do all the heavy lifting on doors that exceed 46,700 pounds.

► For more product information from **SCHWEISS DOORS**, see page 27.

LOCATION:

SpaceX, Cape Canaveral, Florida

DOORS:

One 90' wide x 61' tall Schweiss Bifold Liftstrap door; One 40' wide x 69' tall Schweiss Bifold Liftstrap door, both custom made

PREMIUM

METAL ROOFING+BUILDING COMPONENTS



RESIDENTIAL | COMMERCIAL | POST-FRAME | COMPONENTS



AMERICAN
BUILDING
COMPONENTS

ABCMetalRoofing.com

American Since 1908

Adel, GA
888-446-6224

Lubbock, TX
800-481-3035

Memphis, TN
800-206-6224

Nicholasville, KY
800-877-8709

Omaha, NE
800-228-2260

Oklahoma City, OK
800-345-0044

Oskaloosa, IA
800-345-0044

Phoenix, AZ
800-481-3035

Rome, NY
800-544-2651

Salt Lake City, UT
800-481-3035



Circle Reader Service #390



LOCATION:

Salt Lake County Fleet Management Building, Salt Lake City, Utah

SIZE:

Service area with 22 bays: 34,000 square feet; administrative area: 6,500 square feet

ARCHITECT:

Kevin Blalock and Partners, Salt Lake City

CONTRACTOR:

Ascent Construction, Salt Lake City

CONSULTANT:

Maintenance Design Group, Denver, Colorado

DOORS:

14' wide by 16' tall Amarr 2742 doors with 3552 aluminum sections; 27 gauge steel for both interior and exterior skins, custom color; 2" R-19.4 foamed-in-place polyurethane insulation

DOOR INSTALLER:

Frontier Door, Cedar City, Utah

FEATURES:

Metal screen awnings shields office windows from direct sunlight on the south façade, its bi-fold design a reference to folded metal automotive design. The east façade welcomes morning light with high performance windows.



MAINTENANCE BUILDING

Amarr

www.amarr.com



Mixing block and steel, this building shows the versatility of steel and the ability to build green. The LEED Gold Certified project takes its inspiration from the 1970s muscle car era, merging heavy internal machinery with a sleek external skin. The doors are used as a design element, with high performance glass allowing for optimal daylight and viewing safety. It was a complex lift installation. Each door lift was embedded within the structure between the structural columns and below the window sill plate. A double girder bridge crane system runs the length



of the building. A fire sprinkler system is below the door and mechanical, lighting and structures above. Because the roof slopes end-to-end, each horizontal track is at a different height, making for very tight tolerances.

► For more product information from AMARR, see page 26.

Become an Accredited Post-Frame Builder

and be publicly recognized for your commitment to professionalism and quality in ethical business practices, safety, and education.



The Accredited Post-Frame Builder (APFB) Program recognizes builders who embrace programs and policies that promote quality and customer satisfaction. APFB status sets your company apart from the competition and entitles you to use the APFB logo on your company letterhead, business cards, and other marketing materials. In addition, your company is highlighted in the "Find a Builder" section of the National Frame Building Association (NFBA) website (www.nfba.org), in the membership directory, and at the Frame Building Expo.

As an Accredited Post-Frame Builder, you are authorized to use the following language on all bid documents:

(Your Company Name) has been recognized by the National Frame Building Association as an Accredited Post-Frame Builder for its commitment to ethical business practices, safety, training, and high-quality service.

To renew your accreditation every 2 years, one or more employees of your company must earn 12 continuing education units (CEUs) within that time by attending educational programs at the Frame Building Expo, NFBA webinars or chapter programs, or other preapproved events.

As industry professionals, we want our customers and the general public to know that we care about industry standards, high-quality workmanship, safety, and ethical business practices. Set your company apart from the competition by becoming accredited. The first step is to complete the application and return it with your payment.

Your participation in the Frame Building Expo educational sessions will count toward your accreditation. Stop by the NFBA booth to fill out an application form and learn more.

Post-Frame Builder Accreditation is an NFBA member benefit. Not a member? Come to the NFBA booth to introduce yourself and join today!

Standards of Professional Conduct

Inasmuch as it is my belief that my reputation in the building industry is dependent upon my devotion to the highest ideals of honesty, courtesy, and integrity, as evidenced by my willingness to conduct business in a spirit of fairness and equality for all, and inasmuch as the National Frame Building Association has dedicated itself to the same high ideals of professional responsibility, I hereby agree to abide by and to conduct business in accordance with the following Code of Ethics:

1. I shall at all times **exercise the utmost integrity** in all of my business transactions and in all my relations with customers, employees, suppliers, and competitors.
2. I shall **refrain from the use of false or misleading advertising** and will honor the written and approved purchase agreement made with my customers.
3. I shall **make no false statements** or circulate harmful rumors about my competitors' product, business, or financial or personal standing.
4. I shall endeavor to **abide by present and future building standards** of the National Frame Building Association.
5. I shall make every effort to **preserve my customers' trust and good faith** by providing the service and repair parts that they may need.
6. I shall **dedicate myself to the promotion of professionalism** within my industry, and I shall work diligently to build and perpetuate continuing consumer faith and trust in National Frame Building Association builders.
7. I shall faithfully **stand behind the work I perform** and the products I sell, in accordance with manufacturers' recommendations and warranties.
8. I shall, in good faith, **furnish to the proper building authorities all certifications** regarding professional or structural engineering and loading standards that are required of me.
9. I shall **encourage my fellow employees, my fellow members of the National Frame Building Association, and my colleagues to adhere to this Code of Ethics.**



The accreditation program recognizes the effort we make to stay informed and maintain a business that focuses on integrity."

—Brian Keane, National Barn Company, Fort Gibson, OK





LOCATION:
West Tisbury,
Massachusetts

SIZE:
30'x135'x14'

BUILDING SYSTEM:
Armstrong Steel Buildings
rigid frame system

FEATURES:
Wooden roof, eaves, doors
and end walls

WAREHOUSE

Armstrong Steel Buildings

www.armstrongsteel.com



Designed to fit into a century old farm center on Martha's Vineyard, this warehouse features a gray oxide rigid frame system, along with pre-galvanized secondary framing (including the building's support purlins and girts). This isn't your standard cookie cutter design. The owner finished the exterior build out with a wooden roof, eaves, doors and end walls.

► For more product information from **ARMSTRONG STEEL BUILDINGS**, see page 22.



Energy Efficient Vinyl Windows.

WINDOW STYLES:

- SINGLE HUNG
- DOUBLE HUNG
- SINGLE SLIDER
- DOUBLE SLIDER
- PICTURE WINDOW
- CASEMENT
- BAY / BOW
- AWNING
- HOPPER
- ARCHITECTURAL SHAPES



Maintenance free vinyl

Triple weatherseal on sash

Permanently fusion welded main frame and sash



All Harmony Windows Include:

Optional internal woodgrain and extension jambs

Extra thick 70 mil, multi-chambered vinyl frame and sash

Standard Low E / Argon filled glass

Double strength insulated glass

Optional internal grids are color matched



Building Ideas

A.J. Manufacturing, Inc.
1217 Oak Street
Bloomer, WI 54724

800.328.9448 www.ajdoor.com

Available with A.J.'s Patented EZ-v™ Trim, Installation & Flashing System.

Circle Reader Service #334



FEED STORE

Replications Unlimited

www.replicationsunlimited.com



The architect originally designed this project with a manufactured stone system. The cost of using masons and stone on this project, however, turned out to be costly, especially due to the number and complexity of the columns and flower box elements. The Urestone system was recommended by the contractor because large pre-engineered 8 foot wainscot panels were available and the product line also included both 16 and 24 inch column kits. By using a faux stone panel over a masonry product, the builder was able to cut installation time and costs. The installation of these faux stone panels took two workers four days to accomplish. The panels also add an R-value of 5-6.

► For more product information from **REPLICATIONS UNLIMITED**, see page 34.

LOCATION:
*Odessa Feed Depot,
Odessa, Florida*

BUILDER:
MTL Steel Inc.
SIZE:
70' x 100'

BUILDING SYSTEM:
*Metal engineered
building*

EXTERIOR PANEL:
*Urestone Ledgestone
Wainscot Panels
42" high x 96" long*

Your guide to post-frame and metal building supplies

From the ground up to the roof, the following product profiles will help you build the best post frame or metal building your customers demand. Use the following index to quickly find what you're looking for.

Post Frame & Metal Building Systems.....	22	Roof Clamps	34	Adhesives, Sealants & Caulks	46
Nails & Screws	23	Snow Management.....	36	Insulation.....	49
Doors	26	Wind Uplift Control	38	Ventilation.....	50
Door Hardware	28	Underlayment	38	Moisture & Vapor Barriers.....	52
Windows	29	Retrofit.....	38	Trusses & Columns	52
Skylights & Daylighting	30	Coil.....	40	Foundation Products	53
Roof & Wall Panel	31	Cupolas.....	40	Equipment	54
Interior Wall Panel	34	Paint & Coatings	44		
		Recoatings.....	45		

POST FRAME

Graber Post Buildings |

Circle 101

Graber Post Buildings continues to be a phone call away from acquiring all post-frame building materials and do-it-yourself packages. GPB manufactures metal panels for any residential, commercial, industrial, agricultural or roofing application. It also produces custom trusses, metal trims, laminated poles and also now features a steel coil division.



Wick Buildings |

Circle 102

Wick Buildings is a leader in the post-frame industry, founded in 1954 and with more than 71,000 buildings completed. Wick builds everything-from industrial and light manufacturing facilities to banks and aviation buildings, from gas stations and churches to equine and livestock facilities to storage facilities. As a Wick builder you'll have a building partner with

corporate strength and a name you and your customers can trust.

METAL BUILDING SYSTEMS



Armstrong Steel Corporation |

Circle 103

Rural builders choose Armstrong Steel because quality components is matched only by the ease of erection. Pieces are pre-cut and pre-drilled, saving costly on-site assembly, plans are simple to understand, and with an in-house engineering department, Armstrong is able to modify designs and meet rural permitting requirements quickly. A central logistics and freight department ensures that your customer's building is delivered on time and includes all the parts necessary for quick erection.

Metallic Building Co. |

Circle 104

Metallic Building Company's Long Bay System enables fast and affordable con-



struction of buildings that require large, open floor space. The Long Bay System may also help reduce total project time up to 30 percent. Metallic is a leading division of NCI Building Systems, one of the largest integrated manufacturers and marketers of custom-engineered metal buildings.



Sukup Steel Buildings |

Circle 105

Sukup Manufacturing Co.'s pre-engineered steel buildings feature clear span construction and standing seam or screw-down roofs. The clear span design allows for flexibility in customizing interior

space to meet customer needs. Purlins and girts are galvanized for long-life and pre-punched to ensure proper fit and faster installation. A variety of sidewall and trim colors and options are available.



Varco Pruden Buildings | Circle 106

Through advanced engineering and proprietary building products, Varco Pruden provides innovative steel building solutions worldwide for low-rise commercial

projects including offices, warehouses, schools, manufacturing plants and retail spaces. With six strategically located service centers, multiple production resources and a network of more than 1,000 builders within the U.S. and Canada, Varco Pruden is a market leader in the industry.



Worldwide Steel Buildings | Circle 107

Protect what matters. Worldwide Steel Buildings has more than 30 years experience designing and manufacturing the

strongest and most reliable metal and steel buildings. Worldwide opened its truss plant in 1983, and currently owns and operates the largest open-web truss facility in the industry.

NAILS & SCREWS

Dynamic Fastener | Circle 108

D.F. brand self-drilling screws are used for stitching and sheet-to-structural applications. Clip screws require a low



clearance head when fastening to steel or wood. The D.F. Fenderhead line includes the #14 self-drilling T-5 fastener. Available at 1-1/2 to



- ~Pre-Engineered Trusses~
- ~Laminated Columns~
- ~All Accessories~
- ~Metal Roofing~
- ~Lumber~
- ~Trims~

“WORKING HARD FOR YOUR SUCCESS”

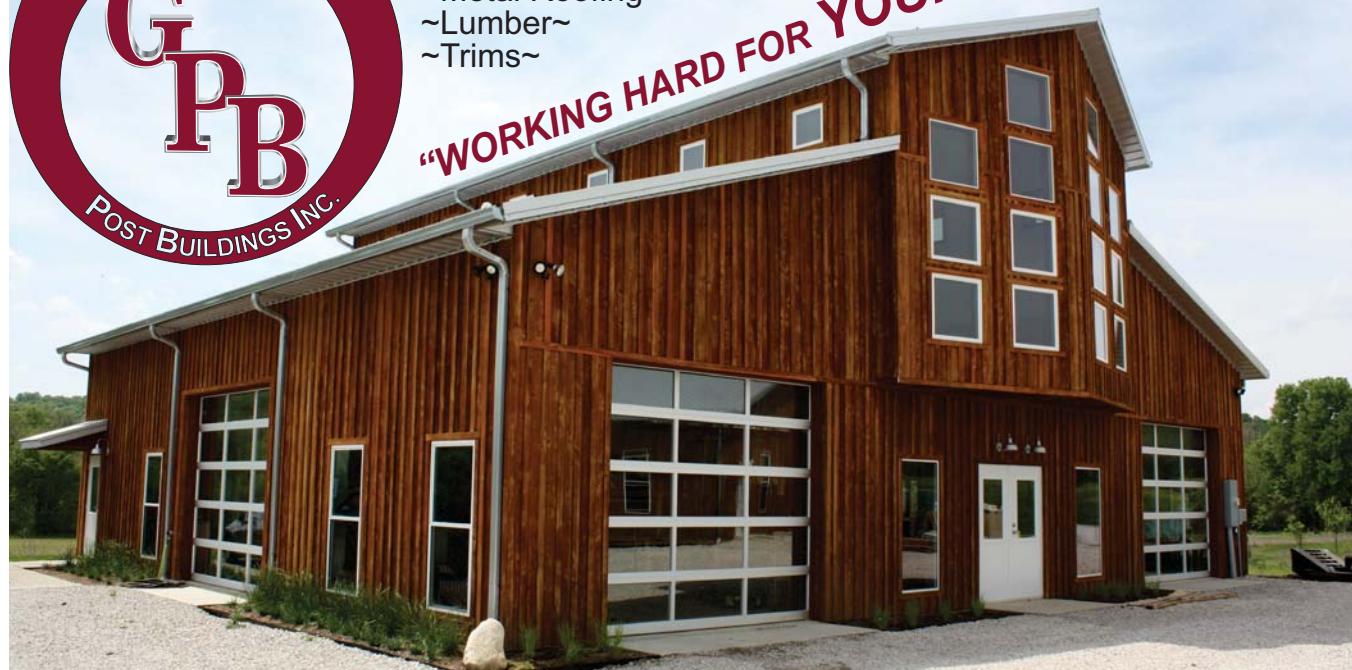

RESIDENTIAL - COMMERCIAL - FARM & AG - EQUINE
 Graber Post Buildings, Inc., 7716 N. 900 E., Montgomery, IN 47558
 800.264.5013 | Fax 812.636.4936 | www.graberpost.com

Circle Reader Service #433

products

NAILS & SCREWS

8 inches long, the T-5 will fasten steel to structural steel from .250 to .625 inches total steel thickness. The 3/8-inch HWH also comes with a large 5/8-inch O.D. washerface. Fenderheads are available with the Dyna-Coat 1,000 hour salt spray premium coating.



East Coast Fasteners | Circle 109

East Coast Fasteners produces durable, long-lasting fasteners for all combinations of building materials. The Ply-Lo 410 is designed for attaching Galvalume and other long life panels to wood frame buildings. They are manufactured from 410 stainless steel, coated with Ultraseal and tested to more than 1,000-hour salt. The 304 stainless steel bonded sealing washer provides lifetime protection from red rust. The vulcanized bonding of the washer eliminates separation of EPDM from the metal backing.

Fasco America | Circle 110

Fasco America offers a full range of



Jumbo Nails and two well-designed tool models to conquer BIG timber framing jobs. These tools have a side handle for extra support while driving the Jumbo Nails. Jumbo Nails are available in 4 inch to 6-3/8 inch lengths and can be ordered in many different finishes, shank deformations, points and collations to meet your exact needs.

Leland Industries | Circle 111



One Steppers are thermal expansion fasteners designed to attach fiberglass or PVC panels to wood frame substrates. The revolutionary design self drills an expansion hole, allowing the panels to float, preventing cracking caused by expansion and contraction. The unique wings located on the shank, ream the drilled hole, allowing the panel to move. One Steppers are available to handle panel thicknesses to .750 thick. Hex washer or pancake head design are available in carbon steel or stainless material.

Levi's Building Components | Circle 112

Ensuring a weather tight seal for metal to metal installations is easy with the new ProZ SD. A strong cap withstands the



toughest installation conditions and is compatible with all metal finishes. The design of the washer head reduces over-driving and the zinc aluminum alloy cap can never red rust. It features a 25 year warranty and is available in self drilling #3, #5 and stitch drill points.



Maze Nails | Circle 113

Maze is the exclusive manufacturer of Stormguard double hot-dipped galvanized nails with a lifetime warranty against rust. In business since 1848, Maze offers a full line of specialty nails in bulk for hand driving and in collated sticks and coils for popular pneumatic nailers. Maze post-frame nails meet the all-important ASTM F 1667 specification. In addition, Maze manufactures nails for fiber cement siding products, cedar and redwood sidings, fencing, decking and roofing. Proudly made in the USA in Peru, Illinois.



Sealtite Building Fasteners | Circle 114

Drill quality and corrosion resistance are showcased on the Maxx Steelbinder drill screw and Kwikseal II post-frame screw. Both products are greatly enhanced by Sealtite's powder coat paint process, which improves corrosion resistance 300



LAM-PLY TRUSS

The Truss That Will Carry The Load

- Spans up to 72 ft.
- Spacings up to 12 ft. on center, depending on the load you desire
- Bird Nesting Control
- Better Ventilation & Visibility
- No Feed Alley Post Obstruction
- Additional Ceiling Height

Starwood Rafter Uses

- Pole Sheds
- Free Stalls
- Pavilion Shelters
- Machinery Storage
- Riding Arenas
- Solar Barns



Starwood Rafters, Inc.
W24141 Starwood Lane
Independence, WI 54747
(715) 985-3117 • 888-525-5878

www.starwoodrafters.com

Circle Reader Service #375

percent versus wet-paint processes. The WoodBinder ZXL zinc-aluminum alloy molded head has a 40-year warranty and is the perfect choice for metal roofs that carry a 40-year warranty. Solid and vented foam closure strips, pipe flashings, snow guards, pancake and wafer head screws for standing seam roofs, and other accessories round out the product line.

SFS intec | Circle 115

SFS intec is a premier manufacturer of fasteners for metal panel attachment for metal building and post-frame markets. The #12 Woodgrip XG, with a large aggressive thread design, provides superior performance in OSB and plywood. Other fasteners include #9 Woodgrips, #10 HiLo MP, EverGrip bi-metal screws, and WoodZAC and WoodMAC SS capped fasteners. Accessories include



ProfileVent ridge ventilation, pipe flashing and WG-7 foam closure.

Triangle Fastener Corp. | Circle 116

TFC specializes in supplying hard-to-find fasteners and accessories used in a wide range of roofing applications, offers job-site support, and can help you select the correct fastener for your application. Just



released is TFC's new "Market Specific Catalog" for the metal building, metal roofing, and post-frame industries, providing product details and technical information.

"Still Making a **WORLD OF DIFFERENCE**"



EZ TITE FASTENER

PLY-FAST SEALER

PLY-LO FASTENER

METAL FAST SEALER

PLY-LO LOW PROFILE FASTENER

- Colors to match any Rollformed Steel
- Hundreds of Closure Styles & Angle Cuts
- Dozens of Sales Professionals
- Factory Delivery Fleet & Fast Delivery
- High Quality Products for any Application



800.558.5895 • Fax: 800.257.5926 • www.plyco.com • Elkhart Lake, Wisconsin

Circle Reader Service #498

DOORS

A. J. Manufacturing | Circle 120



A.J. Manufacturing builds high quality steel walk doors with flush, 6-panel, crossbuck, 2-panel and textured skin panels along with several lite options. AJ doors are built with G60 galvanized steel, pre-hung in steel or aluminum

frames with 4 inch x 4.5 inch fixed pin or ball bearing hinges. The 1-3/4 inch doors are polyurethane foam injected for an R-12 insulating value. AJ doors have been independently tested and meet Florida coastal and Texas wind load requirements.



Amarr | Circle 121

Nothing can make a post-frame building look as unique as an Amarr Classica garage door. Visually, these doors have the appearance of a vintage wood door, but they are made of sturdy, low-maintenance steel. Amarr offers numerous designs and applications to fit any building and budget, and prides its self in having the largest distribution network in the industry. They promise: "We can get any door to any location in America."

CannonBall:HNP | Circle 122

CannonBall's entry door offerings meet a wide range of builder needs. The new 1900-Series provides high aesthetics, steel construction and multi-use functionality in



agriculture, commercial and metal building settings. 2000-Series specialty doors offer thermal breaks, fire rated models, increased durability and a full range of door accessories. Value line 1700-/1800-Series doors have rolled and capped-edge looks and a variety of available panel skins for agriculture projects. Optional hardware and accessories can be factory installed on all models.



DBCI | Circle 123

For more than 25 years, DBCI has been a premium source for steel curtain roll-up doors. A driven and innovative company, DBCI has a door to suit your every need: light- and heavy-duty doors for high-use commercial applications, wind-rated doors, and a complete line of doors and accessories for self-storage locations.



Extrutech Plastics | Circle 124

Extrutech All Weather Doors are corrosion proof, bright white, flat, smooth, 1-3/4 inch thick PVC door panels with solid PVC frames and weatherstrip sealed edges. Available are single and double doors in standard or custom sizes, as well as replacement door panels to fit existing frames for use in high moisture or corrosive areas

where other types of doors just don't last. Use as interior passage doors for car washes, clean rooms, food processing and agriculture.



Hydroswing North America | Circle 125

Hydroswing's powerful, field-proven, precision-engineered, all-steel single panel hydraulic doors are pre-hung in their own frame and have superior sealing ability. Perfect for post and frame hangars, commercial, architectural and agricultural applications and beyond. Always custom, Hydroswing doors are available from 10 feet to 120 feet-plus for any project.



MWI Components | Circle 126

MWI Components is an industry-leading manufacturer of dutch doors, bale doors and sliding doors. Powder-coated parts are offered in more than 28 colors and more than 100 options for 29 gauge inserts. Track packages are available to finish slider installation or you may choose your own components from MWI's track and hardware catalog. Add the final touch using MWI's expansive line of Arcadian doors.

Plyco Corporation | Circle 127



If you're looking for a commercial, residential or agricultural door, Plyco has the right door for your construction projects. Contractors rely on Plyco for a comprehensive line of durable walk doors that meet today's building codes. Plyco offers pre-hung service doors individually packaged, pre-drilled for lock set, and insulated with injected polyurethane foam. Plyco's extensive line of walk doors include factory installed window lites, locksets, panic bars, pulls, plates and other accessories to fit your project needs. Plyco walk doors are perfect for post frame, metal frame and commercial buildings. In addition to walk doors, Plyco's EQUUS Dutch Door System

is built tough to last and is ideal for use as an exterior or interior door for tack rooms and offices. The Champion Slide Door is designed to match the EQUUS Dutch Door in appearance to give your building project that professional touch.



PowerLift Hydraulic Doors | Circle 128

PowerLift Hydraulic Doors is North America's largest hydraulic door manufacturer.

With more than 23 years experience, PowerLift custom designs and installs doors for agricultural, aviation, commercial or residential projects. Each local PowerLift manufacturing location offers the industry's only lifetime structural warranty. For doors built to last a lifetime contact PowerLift.



Schweiss Doors | Circle 129

Schweiss Doors has been a leading manufacturer of hydraulic one-piece doors and patented Lift Strap/Autolatch Bifold Doors for more than 35 years. Re-

New

One-Piece

800-746-8273

DOORS

- AG DOORS
- SHOP DOORS
- BARN DOORS
- AVIATION

...Lift Straps

Say YES... to Strap-Lift Doors

Say NO to Cable Lift

Get More for Your Money!

2015
RB

HYDRAULIC — OR — BIFOLD

"One-Piece" DOOR

STRAP LIFT and auto latch

0489

The Door Leader * **SCHWEISSDOORS.com**



Consider
The **BEST**



SNOW GUARDS

PC240



6500



55RF

Available
in **40+**
colors

FASTENERS



ProZ SD

Metalgrip

Available
in **ANY**
color

Pancake Head



METAL ROOFING ACCESSORIES



**Butyl
Tape**



(877) 897-7020

www.levisbuildingcomponents.com

Circle Reader Service #392

products

DOORS & DOOR HARDWARE

nowned for quality craftsmanship, Schweiss' custom-made engineered doors are specially designed for many applications including commercial, industrial, agricultural, residential, hangars and designer doors.

DOOR HARDWARE



Doorbrim | Circle 130

Doorbrim door awnings, made in America, are an economical solution for protecting doors, windows and hardware from Mother Nature. They prevent premature costly repairs and stops leaking, extending the life of doors, jambs and hardware. Doorbrim door awnings are made from durable ABS plastic with UV protection. Stainless steel masonry fasteners are included. They are available in two thicknesses and three colors.



National Hardware | Circle 131

National Hardware's track and hanger products deliver dependable performance for farm and commercial sliding doors. The vigorously-tested systems promise increased stability and longevity to support heavy doors. As the leader in builder's hardware, National Hardware supplies a full range of products including three different door systems, two types of rails and accessories to reinforce, seal, guide, stop and secure sliding doors.



Richards-Wilcox | Circle 132

Richards-Wilcox manufactures three styles of decorative flat track hangers and track to lend an authentic historic look to sliding door systems of light to medium duty capacity up to 400 pounds. Choose from top mount, traditional or arrowhead hanger designs, all of which are finished in durable black powder coat and have 2-1/8 inch diameter zinc plated steel wheels with sealed bearings for quiet operation and long product life. Products are made in the USA and have a 10 year warranty.



**BOX and
ROUND TRACK**

**HORSE STALLS
and ACCESSORIES**

**1-1/2" + 3-1/2"
SLIDING ALUMINUM
DOOR FRAMES**

Western Products | Circle 133

Whether you use box track or round track, you'll find the strength, shape and size you desire in door tracks, hangers, trolleys, brackets, sliding door accessories, doorframes and more from Western Products. Choose from Western's box track options of 400 to 1,000 pound capacity, or its round track at 600 pound capacity. Most track orders are shipped from inventory within three to five business days.

WINDOWS

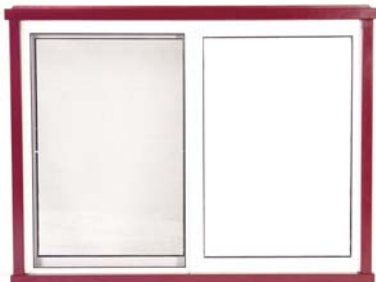

A.J. Manufacturing | Circle 120

A.J. Manufacturing offers a complete line of durable high quality aluminum and vinyl windows. Options include horizontal sliding, fixed lite, casement, single hung, double hung, thermal, non-thermal, grids and Low-E glass. Transom windows and mullion kits to combine multiple windows create attractive architectural features. White,

brown, bronze, clay or custom-colored shutters, windows and trim will enhance the appearance of your next building.



CannonBall:HNP | Circle 122

The thermally-broken 2200-Series aluminum windows hold off winter's cold and are available in slider, hung, fixed and ar-

chitectural shapes. Value models can be found in the 1200-Series' welded vinyl construction and wide assortment of horizontal sliding, single hung, 3-lite slider, fixed and architectural-shaped configurations. Specialty glass is available in both series upon request.

Plyco Corporation | Circle 127

The CTBW (Commercial Thermal Break Window) is Plyco's top-of-the-line commercial quality window. It is constructed of 100 percent thermalized aluminum extrusions with 3/4-inch thermo pane glazing. Plyco also offers AATL (All Aluminum Trimline) windows, an aluminum frame window specifically designed for the metal-clad building industry. The Series 100 energy efficient window is made of "Fibrex," a revolutionary composite material with strength, aesthetic appeal and

Enjoy the reliability of
100%
NORTH AMERICAN

SPECIAL BOLTS - ANY GRADE UP TO 3/4" X 6"

TANK BOLTS



NEW PRODUCTS
• INDENTED SQUARE HEAD
CHIME BOLT

SERRATED FLANGE LOCKING BOLTS



A325 STRUCTURAL BOLTS

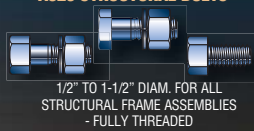

1/2" TO 1-1/2" DIAM. FOR ALL STRUCTURAL FRAME ASSEMBLIES
- FULLY THREADED

CULVERT & GUARD RAIL FASTENERS



WE MAKE NUTS - available in carbon steel & 304-316 stainless steel



WE OFFER CUSTOM THREADING

Canadian Threadall, a division of Leland, is Canada's largest custom threader and can offer you a complete variety of quality threaded products in most ferrous and non-ferrous metals.

- Reverse engineered products from broken or failed samples
- Threading up to 4-1/2" cut and rolled thread
- Thread milling to 16"
- Threaded rods in stock up to 3" diameter in all grades of material
- Bent and formed parts to 4" including "U", "EYE", "J" and "L"



**CANADIAN
THREADALL
LIMITED**



1-800-263-3393
www.lelandindustries.com

100% North American Made

Circle Reader Service #341



energy efficiency (Energy Star). Unlike vinyl, the Series 100 window can be painted and holds its form without warping or twisting. Fibrex windows are guaranteed to hold their form without fading, flaking, blistering or peeling.

SKYLIGHTS & DAYLIGHTING

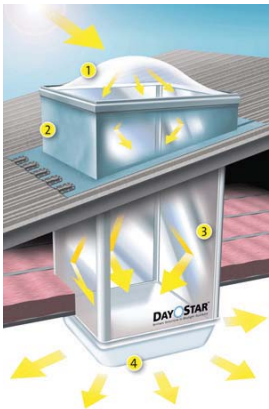

DayStar Systems, LLC | Circle 134

Using a technologically designed, parabolic dome for gathering natural light, the DayStar Daylighting System directs sunlight through an ultra reflective shaft to a specially developed lens for diffusing highly concentrated light into a full, broad lighting pattern. Sunlight is gathered and diffused through an ultra-clear outer dome and inner collimation dome lens. Insulated roof curbs made of Galvalume steel with continuously welded watertight seams are available to match almost any roof pitch and metal rib design. It can now be powder coated to

match your roof color. The insulated panels use a highly reflective interior to amplify light. Aesthetically appealing in open environments, the super insulated light shaft requires no attic support walls and is available in custom lengths.

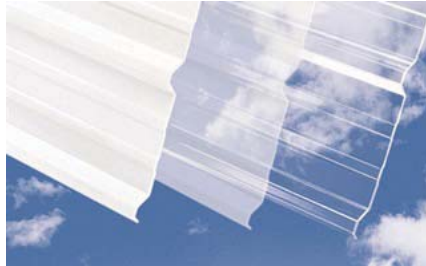

Direct Metals Inc. | Circle 135

Direct Metals Inc.'s newest efforts include providing quality American-made translucent panels that are from 20 percent up to 93 percent thicker than the competition. These new polycarbonate sheets, in 1.0mm and 1.5mm thicknesses, provide specific advantages over the old industry standard of imported 0.8mm thick panels. Benefits include longer warranties and expected product life cycles, product approvals and calculations for wind uplift and snow loads. Installers have noticed that the thicker sheets are considerably easier to install, helping to save time and energy on the job site.

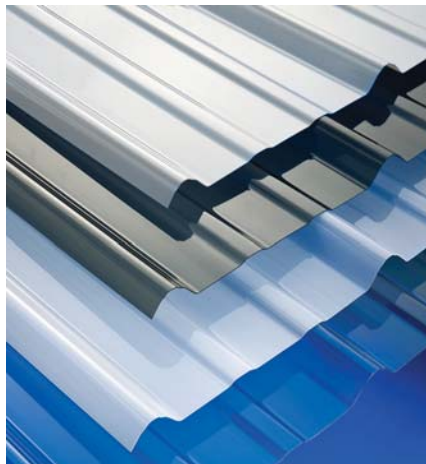

MWI Components | Circle 126

MWI Components supplies a high-quality line of polycarbonate and PVC panels. The polycarbonate panels are produced to high

standards of performance, appearance and accuracy, characterized by high impact resistance, durability and versatility. MWI offers the polycarbonate in clear or opal to meet customers' demands. And with MWI's 24 inch polycarbonate ridge cap, you get effective UV protection, good optical clarity, high light transmission and exceptional impact resistance. The PVC sheet combines high impact resistance, lightness of weight and workability to offer an effective liner panel for agricultural buildings.



Onduline North America Inc. | Circle 136

Onduline North America manufactures Tuffex PVC AgLiner panels 38 inches wide for ceiling and sidewall applications in dairy, hogs and poultry confinement facilities or as an alternative to metal in high corrosive environments. Poly Lite polycarbonate 9- and 12-inch R-Panel is available in clear smoke and translucent white.



Palram Americas | Circle 137

Palram Americas offers SunSky polycarbonate panels for daylighting applications. Palram's proprietary MetalMatch technology allows for rapid matching of existing corrugated metal profiles. As a result, Palram has developed the world's largest catalog of corrugated polycarbonate profiles. SunSky profiles feature co-extruded UV protection. In fact, SunSky is warranted for 10 years against loss of light transmission due to yellowing and against damage due to hail.

ROOF & WALL PANEL

A.B. Martin Roofing Supply |

Circle 138

A.B. Martin Roofing is a manufacturer of quality metal roofing and siding panels including the ABM multi-purpose panel, the ABSeam standing seam panel and the PBR commercial panel. It provides building materials for pole buildings, including framing lumber, insulation, doors and windows, tongue-and-groove lumber and stalls for horse barns and much more.

American Building Components |

Circle 139

With a vision to create lasting partnerships and exceed customer expectations through innovative service, technology and products, ABC offers a variety of



steel panels and accessories. Backed by industry-leading warranties, ABC delivers the highest level of customer service and product performance to ensure successful projects that stand the test of time.

ATAS International | Circle 140

The variations of the ATAS International multi-purpose profile start with the standing seam, to the batten style, to the plank and barn board. The texture

BUILT FOR POST FRAME

THE INDUSTRY'S LEADING MANUFACTURER & SUPPLIER OF ALL YOUR POST FRAME ACCESSORIES

MWI Components offers more color options for your metal building components than anyone else in the industry. With over 100 colors available in steel, 35 different aluminum colors and 50 plus powder coat colors the combinations are endless. This will allow you and your customers to create beautiful and unique buildings using our Cupolas, Ridg-Vents®, Soffit, Trim, Arcadian Sliding Doors, Dutch Doors, Bale Doors and Stall Systems.

MWI Components also offers an extensive line of track and hardware; complete with THREE profiles of slide frame.

1015 32nd Ave West • Spencer, Iowa 51301
ph: 800-360-6467 • FAX: 800-361-3452
www.mwicomponents.com

2015 AWARD WINNER

Circle Reader Service #308

products

ROOF & WALL PANEL

is either smooth or stucco embossed. A slight "V" is formed into the plank or barn board for a variance of style. The multi-purpose panels have a smooth but sleek appearance with a concealed clip-less fastening system.

Central States Manufacturing | Circle 141

Central States Manufacturing produces the highest quality metal roofing and building components for more than 2,000 post frame, commercial, residen-



tial and architectural customers in the United States. Renowned for legendary service and accuracy, Central States promises to deliver outstanding quality metal building components that are "Right, On-Time, Every Time."

**Go Ahead ...
Turn up the HEAT!**

ULTRA HT
WIND & WATER SEAL™
HIGH TEMPERATURE

Ultra HT Wind & Water Seal™ is the premium, self-adhering high-temperature underlayment that is engineered to perform in the most extreme conditions. Ultra HT offers excellent foot traction and self-seals around fasteners. So go ahead, turn up the heat!

Email info@mfbmp.com for a FREE sample and info today.

True 2 Sq. Roll

mfm BUILDING PRODUCTS CORP.
800-882-7663 | www.mfbmp.com

MIAMI-DADE COUNTY APPROVED

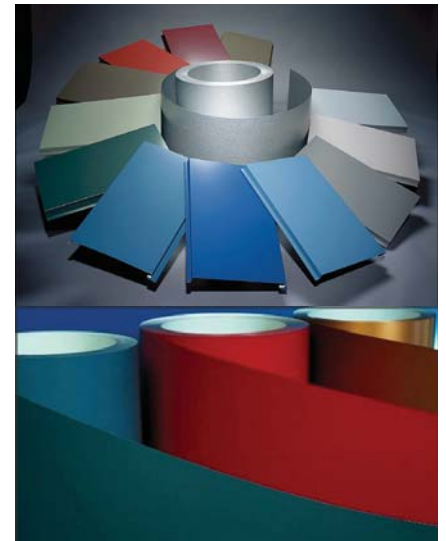

Englert | Circle 142

Englert Inc. is the pre-eminent force in commercial and residential metal roofing and commercial-industrial ACP and IMP wall panel systems. It offers the widest selection of federal Energy Star and LEED-compliant Ultra-Cool coatings produced on the newest, most sophisticated coating line in the world. Englert offers all the roof and wall panel profiles, finishes, textures, architectural details and structural options your customer's design would require.

Everlast Roofing | Circle 143

Everlast Roofing's metal and siding is uniquely superior to anything else on

Circle Reader Service #412

the market. Creating this success is the one-of-a-kind heat forming process, which prevents microscopic paint cracks. This enables the use of harder, more scratch-resistant paints. Offering a variety of gauges, colors and custom trims to suit every customer's application makes Everlast Roofing the perfect choice for the agricultural, commercial and residential markets.

Fabral | Circle 144

Fabral is 48 years strong and offers metal panel solutions, system components and accessories for agricultural, light commercial and residential projects. Fabral's solutions range from the good, to the best to the better. It gets you access to the right system your project demands. Backed by the best support in the industry, Fabral promises to work



with you to get the job done right.

Firestone | Circle 145

Firestone Building Products offers a number of metal roofing panels for various uses on commercial and industrial buildings. Una-Clad UC panels are available in copper, zinc and 31 standard PVDF-painted aluminum and steel colors. All of these panels are compatible with Firestone Building Products' roofing

systems and ISO 95+ GL insulation. The company offers a variety of roofing panels including its Una-Clad UC-3 roofing panel, a double-lock, architectural standing seam metal roof panel.

Integrity Metals | Circle 146

Integrity Metals offers metal roof and wall panels for light-gauge agricultural, light commercial and residential uses. Serving Kentucky and Tennessee, the company is part of the "go green" market with Energy Star products, 40 year warranties and one of the best paint systems.

MBCI | Circle 147

MBCI's Slimline roof panel system offers a sleek contemporary profile ideal for residential applications. This system offers a concealed fastener attachment

TAKE OUR FREE AIA COURSE @www.SnowRetention101.com



Patented

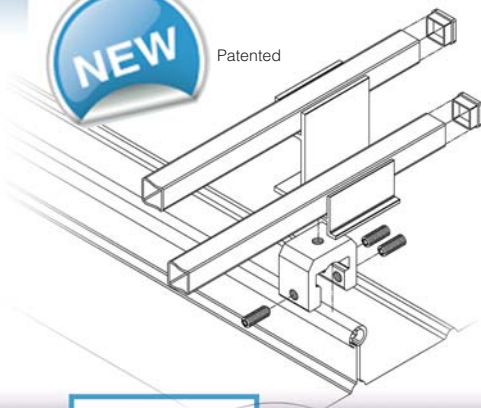

OFFERING THE ULTIMATE IN SNOW RETENTION FOR CORRUGATED, SHINGLE, MEMBRANE AND STANDING SEAM METAL ROOFS



NEW 2 BAR SYSTEM



LARGE COLORBRACKET SYSTEM

NEW 2 BAR SNOW RETENTION SYSTEM

- WILL FIT MOST STANDING SEAM ROOF PANELS
- WORKS WITH COLORBAR OR CAN BE PAINTED TO MATCH



SCAN THE QR CODE OR VISIT THE WEBSITE TO SEE MORE DETAILS @ www.SNOBAR.com

products

ROOF & WALL PANEL, INTERIOR WALL PANEL, ROOF CLAMPS

and may be applied to post frame. Slim-line panels must be specified as striated or striated with minor ribs and cannot be end-lapped. It comes in a 16 inch width and requires a 3:12 minimum slope.



Metal Panels Inc. | Circle 148

MPI produces 15 panel profiles in its plants, including curved panels. The StrongSeam panel line is a through-fastener family of panels available in AG, PBR and Flat-Loc profiles. MPI's standing seam concealed fastener panel line includes 10 panel profiles and two curved panel profiles. All panels are available in several gauges, as well as standard and custom colors.



North Star Metals | Circle 149

North Star utilizes state-of-the-art roll forming and folding equipment to produce consistently top-quality panels and trims exactly to order. A large selection of roll-formed panel and trim is available and CNC folding capabilities allow North Star to satisfy any custom panel or trim requirements, including matching discontinued and hard-to-find panels. North Star also offers on-site delivery with crane-equipped tractor-trailer units and roll-off capable gooseneck trailers.



Replications Unlimited | Circle 150

The Urestone Professional Faux Stone series is the latest technology in interlocking stone/brick panels. Panels are realistic, extremely durable and lightweight. They allow quick and easy installation at a portion of the cost of other systems. The Urestone system is available in large 4x8 panels, a unique wainscot series (typically a 42 inch high panel capped with a built-in top ledge), column kits, pilasters and many trim elements.



World Class Corrugating | Circle 151

World Class Corrugating has proven its ability to supply quality roofing and siding panels with service that is second to none. The knowledge and experience of the WCC team shows in its ability to understand and supply products and services needed for the post-frame and residential roofing markets. WCC is one of the very few manufacturers that provides painted modified siliconized polyester panels in a galvanized substrate.

INTERIOR WALL PANEL

Extrutech Plastics Inc. | Circle 124

The Extrutech FORM System, for dairy and car wash buildings is a stay-in-place concrete form system for 6- and 8-inch



thick, poured concrete structural walls. It's 24 inches wide, up to 20 feet long, with a bright white, smooth, non-porous, easy-to-clean surface, pre-cut to project specifications and snaps together with a double-spline, E-locking system. The company is certified ISO 9001-2008 QMS compliant and a U.S. Government certified supplier.

ROOF CLAMPS

EcoFasten Solar | Circle 152

Rock-It System is a rail-free mounting solution designed with the installer in mind. The system features north-south adjustability up to 4 inches and the unique top-down leveling allows the installer the freedom to level as they go, as well as after the array is installed. One tool (1/2-inch socket) is all that's needed to install any size array, and integrated electric bonding and a built-in wire management tray make the Rock-It System a fast, easy, hassle-free solution.



PMC Industries | Circle 153

Installers of solar racking systems no longer have to contend with wide, L-shaped brackets that prevent complete access to mounting clamp fasteners. The AceClamp L-



Bracket does not cover the top-mounted bolt on the AceClamp ML or impede access to the AceClamp A2 side bolt. The bracket also does not overhang the top of the A2, providing for a better fit and allows complete access to the clamp's grounding cable channel.



S-5!

S-5! | Circle 154

The S-5! clamps and brackets are extraordinarily versatile and allow you to attach almost anything to standing seam, exposed-fastened and corrugated metal roof profiles. Attach solar panels, snow retention, signs, light fixtures, gas piping, antennas, roof walkways, HVAC equipment, lightning protection systems,

conduit, condensate lines, and more—all without violating the integrity of the roof or the roof's warranties.

Sno Gem | Circle 155

Specifically designed for Sno Gem's iClad and Sno Blockade snow retention systems, Sno Cube is an innovative new clamp that attaches to virtually any

ALPINE SNOWGUARDS®

Prevent a roof avalanche...
Keep snow in its place

Snow guards for every roof type

- Custom solutions
- Cost-effective
- Rugged

www.alpinesnowguards.com

Circle Reader Service #317

products

ROOF CLAMPS, SNOW MANAGEMENT

Sno Cube™



standing seam metal roofing profile. It utilizes patent-pending WaveLock Technology that provides unparalleled strength via three points of attachment. Sno Cube's Silver Bullet set screws include a rounded "bullet" tip to maximize strength without compromising the paint finish or the material.

SNOW MANAGEMENT

Alpine Snow Guards | Circle 156

Aircraft-grade aluminum fabrication with increased bracket spacing (up to 48 inches on center), the SnowMax fence-style system from Alpine SnowGuards is



a strong, cost-effective snow management system. The SnowMax-U2 bracket fits most standard double-lock seams and the SnowMax bar accepts a 2 inch wide color insert strip to match roofing material. SnowMax is also available in configurations for both corrugated metal and membrane roofing. All products are made in the USA.

Levi's Building Components | Circle 112

Levi's Building Components has developed a new and improved Snow De-

fender 4500. By adding an embossed groove to this time-tested classic, it has increased the rigidity by more than 40 percent. More colors are also available, with over 40 colors now in stock. Use the Snow Defender 4500 with confidence because Levi's stands behind it with a 15 year warranty.



Sealtite Building Fasteners | Circle 114

Sealtite offers Snow Trax snow guards. Made from 16 gauge 304 stainless steel, Snow Trax requires no sealants for installation, saving money and helping to maintain a finished appearance. Powder coat paint is standard,



BETTER LIGHTING...LOWER ENERGY BILLS. HERE'S HOW:



Powder Coated Roof Curbs

Our Complete DAYLIGHTING SYSTEM

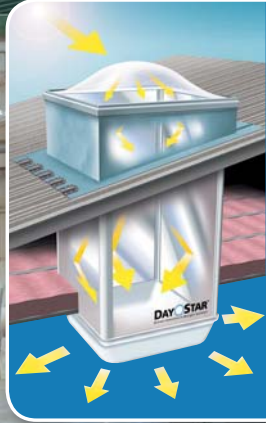
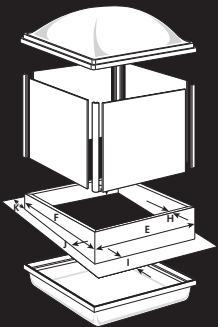

OUR HIGH PERFORMANCE SKYLIGHT SYSTEM'S SOURCE OF ENERGY IS UNAFFECTED BY MARKET PRICES. BECAUSE SUNLIGHT IS ALWAYS FREE.

MBSB-1 TOLL-FREE (866)7-DAYSTAR OR (618) 426-1868 DAYSTAR SYSTEMS, LLC 14226 Hwy 4 CAMPBELL HILL, IL 62916

Circle Reader Service #286

available in 28 colors, as well as unpainted. Snow Trax comes packaged 50 pieces per box and can be added to fastener orders to save freight costs.



S-5! | Circle 154

The S-5! ColorGard sets the industry standard for snow retention systems. It offers unrivaled strength and is the only system to provide an exact color match for the life of the roof. Worldwide, ColorGard is trusted by engineers for its critical holding strength, by architects for its sleek design aesthetics, and by roofers for its patented zero-penetration technology.

Snobar | Circle 157

The first patented bar system in the industry, Snobar offers systems for shingle roofs, exposed fastened roofs and standing seam roofs. Why mess with a two-piece clamp when you can use a one-piece clamp that works on bulb and "T" shaped seams? Snobar systems can be painted to match the roof. The Snobar line also includes a patent-pending two-bar system.



SnoBlox-Snojax | Circle 158

SnoBlox-Snojax offers a variety of snow retention systems for most metal roof

applications. Every product is professionally tested, American made, and most ship the same day. SnoBlox has snow guard solutions with a variety of mounting options including adhesive

attachment, mechanical fastening and non-penetrating clamp attachment. Products are backed with lifetime warranties. SnoBlox-Snojax also offers free system design services.

We have standard fasteners, tools sealants, and accessories

...and much more!

We offer the largest selection of specialty products for the roofing industry. Our proprietary and patented products are designed for superior performance and fast installation.

When you need more...Call TRIANGLE FASTENER

800.486.1832



Visit our website for the most up-to-date product information
www.trianglefastener.com

Circle Reader Service #425

products

WIND UPLIFT CONTROL, RETROFIT, UNDERLAYMENT

WIND UPLIFT CONTROL



Windbar | Circle 159

The first patented bar system with a foot to keep the middle of the panels from up-lifting in high wind areas, Windbar helps to bring existing and new metal roofs up to spec. Not only does Windbar help with wind uplift, it solves many noise issues on standing seam roofs throughout the United States and Canada.

RETROFIT



McElroy Metal | Circle 160

New to its offerings for rural contractors, McElroy Metal recently introduced a quick and efficient method for installing standing seam metal roofing directly over asphalt shingles, without a tear-off. The system is designed around the new patent-pending clip paired with the company's 138T symmetrical standing seam panel. Measuring 1-3/8 inch-

es tall, the 138T is a two-piece mechanically seamed metal roofing system. The system utilizes 3/4-inch deep corrugated metal under the panels at the ridge, hip and headwall locations to support the panel, while providing free airflow or "above sheathing ventilation" for an added energy savings.

UNDERLAYMENT



Atlas Roofing | Circle 161

WeatherMaster Film SE is a silicone-treated, split-back release film created

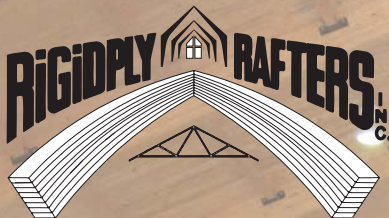

From a simple beam to a complex truss system,
GLUE-LAMINATED TIMBERS
supports your plan with unlimited flexibility!

Equestrian • Agricultural • Residential • Commercial
Arches • Beams • Heavy Timber Trusses • Pavilions • Bridges



701 East Linden Street, Richland PA 17087
Phone: (717) 866-6581 ~ Fax: (717) 866-7237
www.rigidply.com

Circle Reader Service #382

to go under any roofing material. It is ideal for critical transition areas where water can collect or drainage is slow. The SBS modified, self-adhesive underlayment creates a watertight barrier as it seals to the deck and around nails. It provides a secondary layer of waterproofing from wind-driven rain and meets ASTM D1970 standard for ice dam underlayment.



Levi's Building Components | Circle 112

RoloShield 50 from Levi's Building Components is lightweight, stronger than felt and faster to install. Use less rolls to cover more roof and lower your installed cost by using this 100 percent polypropylene synthetic roofing underlayment. It lays flat, is water resistant with superior coverage in valley, ridges and hips. Use the pre-printed nailing pattern for speedy installation. UV resistance material provides a cooler working surface. Ideal for installation under wood, shingle or metal roofs.



MFM Building Products Corp. | Circle 162

MFM Building Products' underlayments

are self-adhering, self-sealing around roofing fasteners, and come with split-release liners for easy installation. MFM's high temperature underlayments include MFM Wind & Water Seal (40 mil), Ultra HT Wind & Water Seal (45 mil), and Storm-

Stopper FSU (45 mil). Minimum installation temperature is 50 F. Each is designed to be installed under roofing at edges, valleys, vents, skylights, chimneys, and as a whole roof covering for secondary waterproofing protection.

The building suppliers you can trust focus on

BUILDING STRONG RELATIONSHIPS.





The most solid foundation upon which to build a partnership is trust. That's why, for more than 60 years, Varco Pruden has focused on creating relationships that last.

Our interest is always your best interest. While we offer decades of experience and expertise, constantly educating ourselves on your environment and consumers, we also take pride in our loyalty and value our credibility. You can depend on us to work for you. Because we're not just reliable, we're dedicated. And we never compete against our builder partners.

We offer superior products and service, including:

- ◆ Unrivaled quality
- ◆ Cutting-edge technology and innovation
- ◆ Unequaled marketing tools and resources
- ◆ A wide array of products
- ◆ Experienced project management and field support

Contact Varco Pruden today. Let us show you how, together, we can add value to your business and your reputation.



Trusted Since 1948



BECOME AN AUTHORIZED VARCO PRUDEN BUILDER TODAY.
Call 1-866-538-0012 or log on to www.VP.com/ad/RBM.

Circle Reader Service #301

products

COIL, CUPOLAS

COIL



Mill Steel Co. | Circle 163

Mill Steel Co.'s Building Products Division proudly offers AkzoNobel and Valspar paint systems on its 29- and 26-gauge panels. It also has a variety of bare steel options to paint to a customer's specific codes. Mill Steel can cover your 29-, 26- and 24-gauge acrylic needs as well as provide materials for your purlin projects.

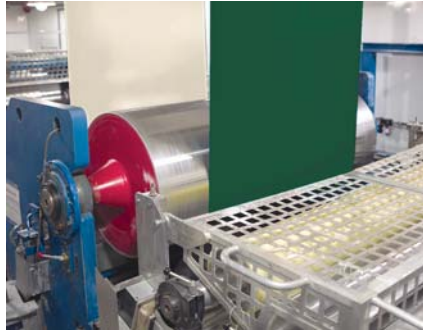

Steel Dynamics | Circle 164

Steel Dynamics is a leader in the production of high-quality, low-cost, pre-painted steel for the metal construction industry. Its wide-width, light-gauge, pre-painted flat-rolled steel is perfectly suited for roof, wall and fascia systems used in the construction of metal structures. Also, SDI's pre-paint lines run parallel to its galvanized and Galvalume lines, reduc-

ing transportation costs and shortening the supply cycle, saving time and money.

CUPOLAS



Ag-Co | Circle 165

Ag-Co cupolas are designed of durable, high-density polyethylene that is UV inhibited and will never rust or decay. Main-

BORN IN FIRE

NOW IN 36
POWDERFUL™
COOL
METAL COLORS

40 YEAR
WARRANTY
SEALTITE
STRONG



ZXL WoodBinder®

The journey for all carbon steel fasteners begins in a heat treat furnace. However, it is the engineering excellence & functional, yet attractive design that separates the **ZXL WoodBinder®** from competitive long-life screws.

- Head is molded for maximum pullover strength.
- KWIKSEAL® thread & point designed for today's high quality residential & commercial metal roof panels.
- Available with POWDERFUL™ powder coat paint system.
- EPDM rubber washer fits securely underneath the head.
- Written 40 year warranty against red rust on the head is available upon request.

No Red Rust



Molded ZAMAC 5 Zinc-Aluminum alloy provides maximum protection against red rust

CALL TODAY 800.352.4864



tenance free, they retain their original appearance for a lifetime. Ag-Co cupolas combine the rigidity of polyethylene with the convenience of lightweight construction for quick and easy installation. Thirteen color combinations are offered in Ag-Co's two-piece construction that allows the builder to coordinate a design that best accents the building and customer's tastes. Three sizes are available: 22, 30 and 42 inch bases.



CannonBall:HNP I
Circle 122

The elegant, traditional finishing touch on your post-frame building, CannonBall's cupolas can provide ventilation as well. CannonBall

cupolas are built to last, assembling easily with a unique interlocking system and a formed, stamped roof spline rounded for safety. Available in many colors, the 24 inch and 36 inch cupolas are shipped assembled or knocked down. The 48 inch ships assembled in a crate, ready for installation.



MWI Components | Circle 126

Top 10 award-winning MWI manufactured cupolas offer the perfect decora-

tion for any post-frame project. MWI offers 24-, 36-, 48- and 66-inch choices in its four-sided design. The company also offers an eight-sided octagon design that stands 7- or 12-foot tall. In addition to the vast color selection, customers have the option of specifying their cupolas with louvers or windows.



Plyco Corporation | Circle 127

Curved roof, straight roof, window kit options, premium base and more. Plyco has



EcoFasten Solar®

GreenFasten™ Solar Roof Mount Flashing for Composition Shingles

- Patented, watertight, compression-fit seal
- The strongest and least expensive bracket system available
- Retrofit without removing shingles
- Easy to install
- IAPMO Certified

877-859-3947

info@ecofastensolar.com



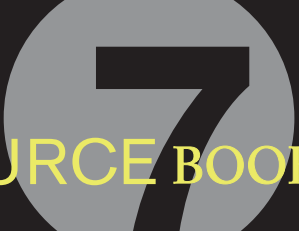

Looking for more information from companies featured in this issue?

Use the Reader Service card facing this page to get **FREE** information from our advertisers!

Free online info at www.bit.ly/info-rbfn

ADVERTISERS

RS #	Company	Page #	RS #	Company	Page #	RS #	Company	Page #
334	A J Manufacturing, Inc.	20	536	Hershey's Metal Meister	53	408	Ritchie Industries	51
291	AB Martin	49	341	Leland Industries	29	450	S-5!	45
390	ABC	17	392	Levi's Building Components	28	414	Schweiss Doors	27, 57
317	Alpine Snowguards	35	412	MFM Building Products Corp.	32	429	Sealtite Building Fasteners	40
441	Aztec Washer Co.	56	308	MWI Components	31		Semmler Systems, Inc.	57
386	Cannonball:HNP, LLC	9		Marion Manufacturing	57	482	Sno Gem, Inc.	44
315	Champion Steel Buildings	54	306	Maze Nails Company	2	588	SnoBar	52
	Clark Industries	57		Metal Rollforming Systems	57	589	SnoBar	33
286	Daystar System, LLC	36	331	Metalcon	55	375	Starwood Rafters, Inc.	24
	Doorbrim	57	378	National Frame Building Assn.	19, 47	345	Sukup Manufacturing	60
316	Dynamic Fastener	59	463	Nationwide Protective Coating Mfrs., Inc.	12	425	Triangle Fastener Corp.	37
366	Eco Fasten Solar	41		Paint Valley Parts, LTD	57	301	VP Buildings, Inc.	39
498	East Coast Fasteners	25	350	Palram Americas	14	484	Valspar Corporation	11
407	Everlast Roofing, Inc.	7	313	Plyco Corporation	5	374	Western Products of Indiana	50
	Extrutech Plastics	57		Power Lift Hydraulic Doors	57	511	Wick Buildings	44
288	GSSI Sealants	48		Replications Unlimited	57			
433	Grabber Post Buildings	23	382	Rigidply Rafters	38			

The index is provided as a reader service. Occasional last-minute changes may result in ads or editorial copy appearing on pages other than those listed here. The publisher assumes no liability for omission or errors.

STORY RESOURCES

A listing of the products and services available from companies featured in this issue. To receive more info from these companies, circle the corresponding RS# (reader service number) on the card facing this page. **For even faster service, fax your completed card to 888-847-6035.**

RS #	Company	Page #	RS #	Company	Page #	RS #	Company	Page #
POST FRAME BUILDING SYSTEMS			111	Leland Industries	24	127	Plyco Corporation	27
101	Grabber Post Buildings	22	112	Levi's Building Components	24	128	PowerLift Hydraulic Doors	27
102	Wick Buildings	22	113	Maze Nails	24	129	Schweiss Doors	27
METAL BUILDING SYSTEMS			114	Sealtite Building Fasteners	24	DOOR HARDWARE		
103	Armstrong Steel Corp.	22	115	SFS intec.	25	130	Doorbrim	28
104	Metallic Building Co.	22	116	Triangle Fastener Corporation	25	131	National Hardware	28
105	Sukup Steel Buildings	22	DOORS			132	Richards-Wilcox	28
106	Varco Pruden Buildings	23	120	A.J. Manufacturing	26	133	Western Products	28
107	Worldwide Steel Buildings	23	121	Amarr	26	WINDOWS		
NAILS & SCREWS			122	CannonBall:HNP	26	120	A.J. Manufacturing	29
108	Dynamic Fastener	23	123	DBCI	26	122	CannonBall:HNP	29
109	East Coast Fastener	24	124	Extrutech Plastics	26	127	Plyco Corporation	29
110	Fasco America	24	125	Hydroswing North America	26			
			126	MWI Components	26			

RS #	Company	Page #
SKYLIGHTS & DAYLIGHTING		
134	DayStar Systems	30
135	Direct Metals	30
126	MWI Components	30
136	Onduline North America	30
137	Palram Americas	30

RS #	Company	Page #
ROOF & WALL PANEL		
138	A.B. Martin Roofing Supply	31
139	American Building Components	31
140	ATAS International	31
141	Central States Manufacturing	32
142	Englert	32
143	Everlast Roofing	32
144	Fabral	33
145	Firestone Building Products	33
146	Integrity Metals	33
147	MBCI	33
148	Metal Panels Inc.	34
149	North Star Metals	34
150	Replications Unlimited	34
151	World Class Corrugating	34

RS #	Company	Page #
INTERIOR WALL PANEL		
124	Extrutech Plastics	34

RS #	Company	Page #
ROOF CLAMPS		
152	EcoFasten Solar	34
153	PMC Industries	34
154	S-5!	35
155	Sno Gem	35

RS #	Company	Page #
SNOW MANAGEMENT		
156	Alpine Snow Guards	36
112	Levi's Building Components	36
114	Sealtite Building Fasteners	36
154	S-5!	37
157	SnoBar	37
158	SnoBlox-Snojax	37

RS #	Company	Page #
WIND UPLIFT		
159	Windbar	38
RETROFIT		
160	McElroy Metal	38
UNDERLAYMENT		
161	Atlas Roofing	38
112	Levi's Building Products	39
162	MFM Building Products	39

RS #	Company	Page #
COIL		
163	Mill Steel	40
164	Steel Dynamics	40

RS #	Company	Page #
CUPOLAS		
165	Ag-Co	40
122	CannonBall:HNP	41
126	MWI Components	41
127	Plyco Corporation	41

RS #	Company	Page #
PAINT & COATINGS		
166	AkzoNobel	44
167	Becker Specialty Coatings	44
168	Dura Coat Products	45
169	Valspar	45

RS #	Company	Page #
RECOATINGS		
170	Nationwide Protective Coating	45

RS #	Company	Page #
ADHESIVES, SEALANTS & CAULKS		
108	Dynamic Fastener	46
171	GSSI Sealants	46
172	Ideal Building Fasteners	46
112	Levi's Building Components	46
162	MFM Building Products	46
170	Nationwide Protective Coating	46
173	Novagard Solutions	48
114	Sealtite Building Fasteners	48
116	Triangle Fastener Corporation	48

RS #	Company	Page #
INSULATION		
120	A.J. Manufacturing	49
174	Coverttech	49
175	Hitz Halter	49
126	MWI Components	49
176	NOFP	50
127	Plyco Corporation	50

RS #	Company	Page #
VENTILATION		
112	Levi's Building Components	50
177	Marco Industries	50
126	MWI Components	50
127	Plyco Corporation	51
114	Sealtite Building Fasteners	51
115	SFS intec	52

RS #	Company	Page #
MOISTURE & VAPOR BARRIERS		
178	Fil d.d. Menges	52

RS #	Company	Page #
TRUSSES & COLUMNS		
179	Rigidply Rafters	52
180	Starwood Rafters	53

RS #	Company	Page #
FOUNDATION PRODUCTS		
112	Levi's Building Products	53
181	Perma-Column	53
182	Plasti-Sleeve	54
183	Post Protector Inc.	54

RS #	Company	Page #
EQUIPMENT		
184	The Brut Post Grabber	54
185	Marion Manufacturing	54
186	Metal Rollforming Systems	56
187	Paint Valley Parts	56
188	Roll Former Corporation	56
189	Semmler Systems	56
190	Swenson Shear	56
191	Variobend	58

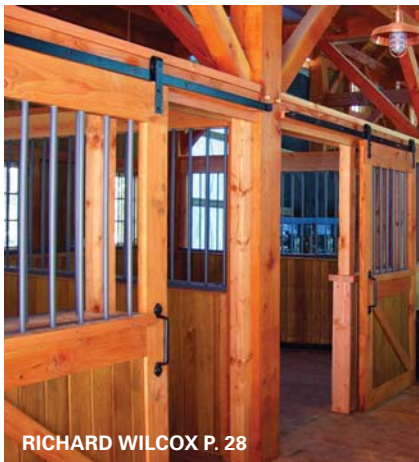

RICHARD WILCOX P. 28

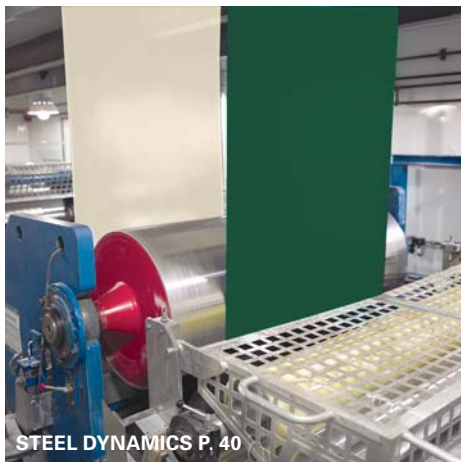

STEEL DYNAMICS P. 40

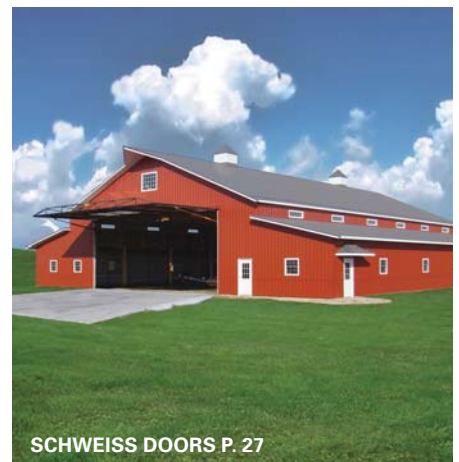

SCHWEISS DOORS P. 27

products

CUPOLAS, PAINT & COATINGS

the cupola to add that finishing touch to your building projects. Available in 24-, 36- and 48-inch sizes, they assemble on the job site in minutes with slide-on metal connectors. Plyco cupolas can be color matched to most roll formed steel colors. Top off with one of several available weather vane options.

PAINT & COATINGS



AkzoNobel | Circle 166

AkzoNobel manufactures high per-

formance coil coatings for the pre-painted metal construction industry, serving the commercial, agricultural, architectural and residential markets. Coil coating products include Trinar, a 70 percent PVDF coating, and Ceram-A-Star1050, which is the industry-leading silicone-modified polyester coil coating. Both are available in Cool Chemistry formulations which help make projects more energy efficient and sustainable.

Becker Specialty Coatings |

Circle 167

Becker Specialty supplies coatings for the industrial finishing of metal and plastic. Its BeckryTherm is high-tech, cool roof, organic coating technology. It features solar reflective, ceramic pigmentation to ensure Energy Star approved solar



emissivity and reflectivity for maximum energy savings. BeckryTherm Interior is a low emissivity back-coating that creates a thermal barrier by reflecting heat into the direction from which it came. BeckryTherm is available in several polymers including super-durable polyester, silicone polyester and full strength PVDF.

SNO GEM

Snow Retention, Solar Panel & Roof Accessory Attachments

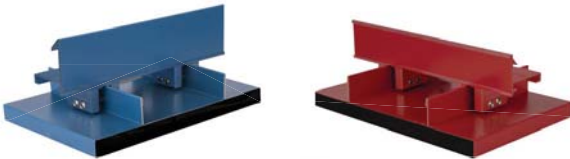

Our **iClad™ Snow Retention Systems** are available in fully coated options.

Call **(888) SNO-GEMS** and speak with your Sno Gem® representative today!



info@snogem.com | snogem.com | (888) SNO - GEMS

Circle Reader Service #482

Exceptional Value and Service

Wick Buildings has been helping Midwest farmers, families and businesses by providing long-lasting, low-maintenance buildings since 1954!

Buildings with quality and value... and no compromises. Join our team!

800-356-9682

WickBuildings.com



Agriculture ▪ Suburban ▪ Equestrian ▪ Commercial

Circle Reader Service #511



DURA COAT PRODUCTS

Dura Coat Products | Circle 168

Dura Coat specializes in high-quality, high-performance coil coatings for commercial, farm and residential applications. Durapon 70 is a PVDF formulation with an exceptional resistance to installation scratching, scuffing and transit abrasion. It is also flexible enough to handle demanding post-forming. The unique chemistry of Durapon 70 reduces the carbon footprint which makes a greener product. Ceranamel XT-40 SMP is a proprietary polymer formulation that is harder and more flexible and significantly more abrasion- and stain-resistant than conventional coatings. Ceranamel has excellent flexibility, weathering and fade resistance properties. Both coatings are energy efficient and meet Energy Star standards.



Valspar | Circle 169

For more than 200 years, Valspar has been a leader in the art and science of coatings that excel in both beauty and function. WeatherXL is the latest in cut-

ting-edge formulation. It is recognized for its durability and offers even stronger protection against weathering and superior scratch resistance. It's ideal for commercial and residential metal roofing, agricultural and industrial buildings and metal wall panels.

RECOATINGS

Nationwide Protective Coating | Circle 170

Alumashield is an aluminum-filled, water-based, low-emissivity interior radiation control coating (liquid applied thermal barrier), designed mostly for application to the underside of a building's roof, but can be applied to the interior sides of exterior walls. Think of a chocolate wrapped in foil to keep the heat out and stop the chocolate from melting. When you coat the underside of the roof with Alumashield you substantially reduce the amount of radiant heat entering the building, blocking up to 77.5 percent. It will also help stop heat inside from escaping during colder months. It has an unlimited life cycle and can be applied to most any surface including wood, plasterboard, metal and concrete.

S-5!® Snow Retention

When snow begins to melt, the result can be catastrophic.

As the blanket of snow avalanches off the roof, it can dump several tons of snow onto anything in its path, damaging landscape, gutters, adjacent roofs, vehicles, and causing injury, or even death, to passers-by. These scenarios are preventable with top-of-the-line snow retention solutions by S-5!®



ColorGard®

Fitted with a strip of the roof material, ColorGard ensures a perfect color-match for the life of the roof.



SnoRail™ & SnoFence™

With up to six times the strength of adhesively-mounted devices, these systems offer a long-term, dependable solution for traditional standing seam and sheet copper roofing.



X-Gard™ — The NEW ultimate pipe snow retention system.

No other pipe snow retention system on the market has proven stronger than X-Gard.



VersaGard™

VersaGard™ is compatible with almost any trapezoidal, exposed-fastened profile. No messy sealants to apply! No chance for leaks!

Connect with us!

@S5_TheRightWay
 /S5TheRightWay



To learn more, call 888-825-3432 or visit www.S-5.com/SnowRetentionMay2015RB

ADHESIVES, SEALANTS & CAULKS



Dynamic Fastener | Circle 108

Drop-Stop sealer was specifically designed for application to metal roofs and problem areas such as gutters, expansion joints, etc. Made from select synthetic rubbers, Drop-Stop is applied as effortlessly as heavy bodied paints. With 1600 PSI tensile and 600 percent elongation capabilities, this unique material actually stretches and recovers to bridge roof joints in which thermal movement can be expected. Also from Dynamic Fastener is Titebond metal roof sealant for exceptional adhesion to Kynar-coated metal materials, standard metal, aluminum, steel, galvanized bonderized surfaces, plastics and glass.



GSSI Sealants Inc. | Circle 171

GSSI Sealants Inc. is an independent, family-owned manufacturer of premiere elastomeric butyl rubber sealant tapes. For more than 30 years GSSI has manufactured standard and custom sealants,

including MB-10A sealant tape for metal buildings, to address the needs of a variety of industries. MB-10A is the preferred tape for metal roofing because of its excellent cohesive and adhesive strength. It meets or exceeds all metal building testing standards and is UL Classified.



Ideal Building Fasteners | Circle 172

Ideal Building Fasteners supplies various sealants and caulks for the metal roofing industry. All products are designed for ease of use to save time and money. Products are field tested and proven reliable for years of maintenance-free sheet laps.



Levi's Building Components | Circle 112

Levi's Building Components is a single source for everything you need to lock nature's elements out of metal buildings. Use these proven products: TiteBond caulk (over 50 colors), EmSeal expand-

ing foam, butyl tape, closure strips and pipe flashing. The Flovent brand of metal roofing ridge vent is tested to withstand driving rain with 100 mph winds. Snow guards are also available.

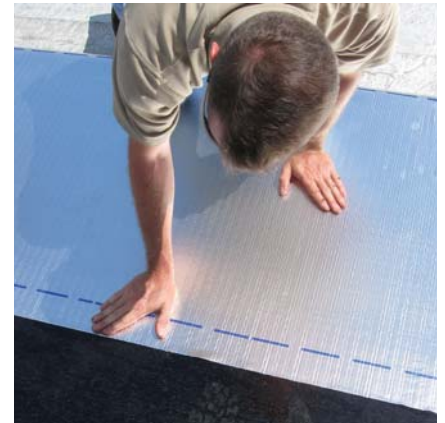

MFM Building Products | Circle 162

MFM is the right solutions provider when it comes to effective waterproofing and weather barriers for all types of industrial buildings, commercial structures, retail properties and private residences. Meeting today's demanding challenges in the construction market is why MFM products are designed for maximum performance, ease of installation and improved profits for its customers.

Nationwide Protective Coating | Circle 170

Alumashield is an aluminum filled, water-based, low emmissivity, interior radiation control coating (liquid applied thermal barrier), designed mostly for application to the underside of a building's roof, but can be applied to the interior sides of exterior walls. Think of a chocolate wrapped in foil to keep the heat out and stop the chocolate from melting. When you coat the underside of the roof with Alumashield you substantially reduce the amount of radiant heat entering the building, sealing up to 82.2 percent. It will also help stop heat inside from escaping during colder months. It has an unlimited life cycle and can be applied to most any sur-

The most **comprehensive** guide for building with post frame



- Eight brand-new chapters
- More than 200 pages
- Hundreds of photos, diagrams, and design tables

Visit www.nfba.org to order your copy now.

NFBA
NATIONAL FRAME BUILDING ASSOCIATION

www.nfba.org

Circle Reader Service #378

products

ADHESIVES, SEALANTS & CAULKS

face including wood, plasterboard, metal and concrete.

Novagard Solutions Inc. | Circle 173

NovaFlex Metal Roof Sealant is a specially engineered silicone sealant (100 percent solids) designed by Novagard to offer superior adhesion to Kynar-coated metal, steel and aluminum metal roof substrates than traditional roofing sealants. It offers improved benefits of superior UV resistance, superior weatherability, tack free in less than 15 minutes, total cure in 24 to 48 hours, low shrinkage, no solvents, extrudes easily down to 0 degrees F, is mildew resistant and VOC compliant.



Novagard Solutions Inc.

Sealtite Building Fasteners I

Circle 114

Sealtite Building Fasteners supplies sealants in both rolls and tubes. Tacky Tape is a 100 percent solid asbestos-free butyl tape roll used on metal building end laps, side laps, pipe flashings and skylights. Urethane and acrylic tube sealants are used on steel, aluminum, concrete and wood. Urethane is used on horizontal construction joints subject to structural movement. Acrylic is used on skylights and window frames. Nova Flex is an inorganic silicone that can be used on all metal roofing panels including copper. It is an excellent choice for use with Roof Jack



pipe flashings. EmSeal is an expanding foam tape infused with water-based asphalt, and used on hip, valley and ridge applications for metal roofs as an alternative to polyurethane foam strips.

Triangle Fastener Corporation I

Circle 116

Triangle Fastener Corporation offers fastening systems for metal-to-metal, metal-to-wood, drywall and concrete applications. With 24 convenient locations and eight in-house painting facilities, TFC also provides expert job site support, technical assistance and inventory management programs. In addition to fastening systems, TFC is a leading commercial construction supplier of tools, sealants and accessories.

GSSI SEALANTS

PREMIER BUTYL SEALANT TAPES

RAIN'S WORST ENEMY

FOR OVER 30 YEARS, MANUFACTURERS AROUND THE WORLD HAVE ENTRUSTED THEIR BUILDINGS' MOISTURE DEFENSE TO THE MOST RELIABLE BUTYL SEALANT ON THE MARKET, MB10A BUTYL TAPE.

800.288.9489 GSSISEALANTS.COM

Circle Reader Service #288



MISS AN ISSUE?

Back issues of *Rural Builder* are now available for **FREE DOWNLOAD**.

Go to: www.ConstructionMagNet.com/download-free-back-issues.

INSULATION

A.J. Manufacturing | Circle 120

A.J. Manufacturing is a distributor of Low-E reflective insulation, the only polyethylene foam on the market. It is waterproof, insect resistant and bird resistant. When a screw is run through the microfoam it is sealed by the hundreds of micro cells, offering extra protection from roof leaks. The closed cell foam has superior PSI rating to support roof panels over purlins. It is Class A/Class 1 fire rated in foil over foil and with white face. The white face is still foil and won't flake when exposed to UV light. Low-E foam insulation is flame adhered, not glued, in a patented process. ESP Low-E reflective insulation meets the requirements of NFPA 286.



Covertch | Circle 174

rFoil reflective insulation is now available in various facing colors. In the past you could only buy a foil or white facing material, now offered are numerous colors to suit your situation or need. rFoil patented technology is specifically designed to reduce radiant heat gain/loss and helps to control condensation in post frame and metal buildings.



Hitz Halter | Circle 175

Hitz Halter Insulation is the simple solution for radiant floor heat applications. It comes with three times stronger film, providing

40 percent better insulation integrity (better stability and performance), and is made with 100 percent virgin material. It offers a simple solution for putting pex tubing down—plastic staples fasten the pex directly to the insulation. It simplifies rebar spacing, tapes together easily, and comes fan folded in 4x24 foot sections for one-man installation. It's a real time and energy saver, and it's tested and proven in real life applications.

MWI Components | Circle 126

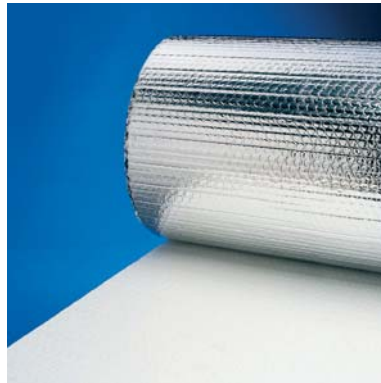

TempShield is a technologically advanced insulation material ideal for new construction or retrofit installation in residential, commercial, industrial, metal buildings and post-frame buildings. It consists of one or two layers of Barrier Bubble air cellular material laminated



A. B. MARTIN
ROOFING SUPPLY, LLC

Roofing & Siding • Hardware • Lumber



AG-TUF®/AG-TUFUV®
Cleans Easily • Durable • Resists Chemicals

AG-Tuf corrugated PVC liner panel allows efficient cladding of structures with many benefits for all types of agricultural professionals. Extremely easy to install and maintain using ordinary tools, while preserving its attractive, glossy appearance over a long period of time.



82 Garden Spot Rd. | Ephrata, PA 17522 | 717-445-6885
35 Ridge Rd. | Newville, PA 17241 | 717-776-5951 | www.abmartin.net

Circle Reader Service #291

products

INSULATION, VENTILATION

between layers of aluminum foil to provide excellent thermal resistance. Offered is a Class A/Class 1 fire rating on white poly/foil insulation. It's available in standard widths of 48 inches and special order widths up to 120 inches.

NOFP | Circle 176

NOFP manufactures high performance reflective foil insulation and under-concrete insulation for commercial, agricultural and residential construction. The Barrier X5 under-concrete insulation is 1-1/4 inches thick and comes in a 4x60-foot roll of flexible EPS foam used for radiant heated floor and goes directly on the grade. It meets the R-5 insulation requirement for most radiant floor installations. It's a great replacement for rigid sheet insulation because it is flexible and won't break when walked on. It also has poly-film layers laminated to the top and bottom so it doubles as a vapor retarder.

Plyco Corporation | Circle 127

Ply-Foil is a multi layer, reflective insulation from Plyco, which comes in rolls consisting of a variety of widths and lengths for use in both specialty and standard construction projects. Two outer layers of aluminum foil reflect 97 percent of the radiant heat. Each layer of foil is bonded to a tough layer of polyethylene for strength. The inner layers of bubble pack resist conductive heat flow while a center

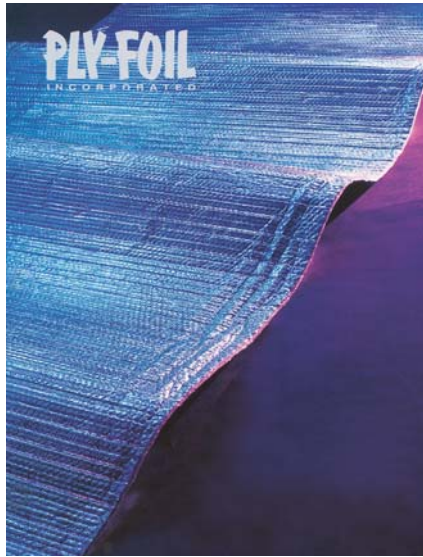

layer of polyethylene gives Ply-Foil additional strength. Ply-Foil provides nominal 3/16-inch thick Single Bubble, nominal 5/16-inch thick Double Bubble, Standard Edge and Staple Tab product lines for both metal and post-frame construction. Perfect for new construction or retrofit.

VENTILATION

Levi's Building Components | Circle 112

Levi's Building Components offers simple solutions to prevent weather element damage for varying roof profiles with FastVent and FloVent—two contractor-friendly metal roofing ridge vent closure systems. Both are easy to install with a

Metal Roofing Ridge Vent



pre-applied adhesive strip and are fire retardant and UV stable. Each fit many profiles: FloVent can be installed on the ridge cap and FastVent on the eave. Increase the longevity of your metal roofing with an easy install of these two products.

Marco Industries | Circle 177

Marco's LP2 product improves ventilation, eliminates condensation, and is available at costs lower than traditional fans and louvers, plus LP2 offers a 40-year warranty. Made from non-fabric-covered Python vent material, this durable, modified polyester has a non-woven, non-wicking fiber-based matting for superior net-free ventilation that helps keep out moisture, pests and dusts. Installation is easy with Marco's superior peel and stick adhesive, fasteners and specially-cut contours designed for a low-profile fit with any pitch roof and most major metal roof profiles.

MWI Components | Circle 126

MWI is leading the industry in natural ventilation. Not only does MWI supply

ROUND TRACK

YOU'RE ON THE RIGHT TRACK WITH **WESTERN**



600-lb. capacity, smooth, easy gliding round track. Self-cleaning design, corrosive resistant 14 gauge galvanized construction.

(800) 553-5142 www.westernproductsinc.com

ALSO FROM WESTERN: 1 1/2" + 3 1/2" SLIDING ALUMINUM DOOR FRAMES

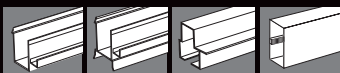

WESTERN PRODUCTS OF INDIANA

Circle Reader Service #374

products

VENTILATION



Uni-Vent II and Uni-Vent III to ventilate with a ridge cap but also manufactures five profiles of Ridg-Vents to provide outstanding ventilation. Ridg-Vents exhaust air out of an attic or whole building. When used in conjunction with vented soffit, Ridg-Vents provide superior ventilation. Customers also have the option of choosing a fiberglass diverter on some models to allow natural light into a structure. With over 100 colors to choose from, MWI can match most manufacturers' steel colors.

Plyco Corporation | Circle 127



Plyco manufactures and distributes a variety of ventilation products designed to meet most airflow requirements. The MWE-100 is a low profile unit, 10 feet in length with 12 square inches of free air space per lineal foot. The MW100-25 has a higher profile than the MWE and is

open at the top. The ventilator has an internal diverter to direct rain off to the side and out onto the roof. The free air space per lineal foot is 30 square inches and it is 10 feet long. The MW100-35 has the same design as the 25 series with increased free air space of 36 square inches per lineal foot. The ventilator rises 4 inches above the ridge and comes 10 feet in length. The FMW100-35 is of the same design as the 35 series but the diverter is made from translucent fiberglass. Having the translucent fiberglass diverter allows light into the building ridge while keeping the rain out.

Sealtite Building Fasteners | Circle 114

Sealtite Building Fasteners supplies its MultiVent and MultiVent10 vented closures for those applications requiring air flow on metal roofs. Made from open cell foam, MultiVent allows as much as 98 percent free airflow through the material, however

**YOU NEVER FORGET
WHERE YOU CAME FROM...
NEITHER DOES RITCHIE.**

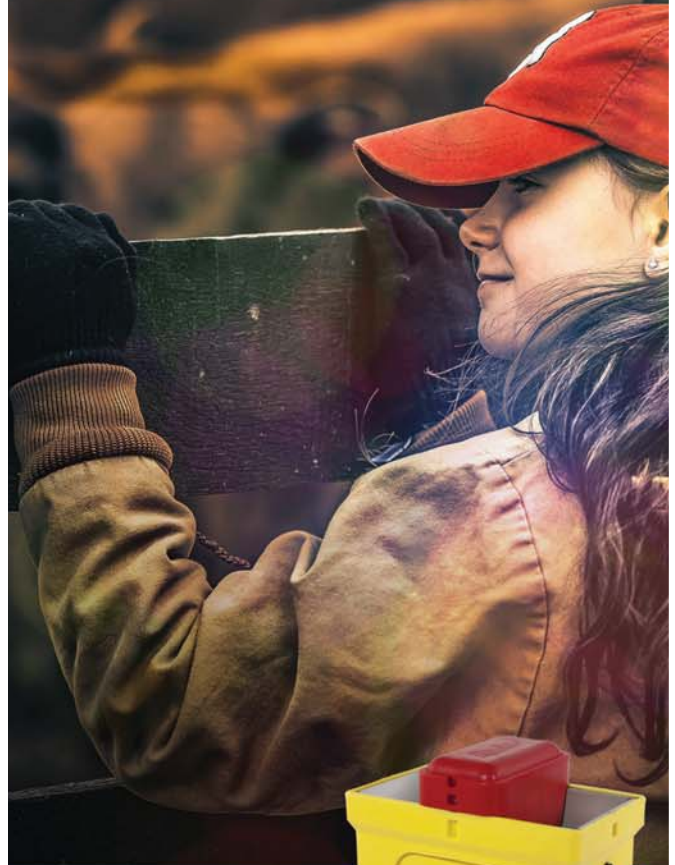

It's what's on the inside that defines us.
You know it, and we know it.
Because we share the same values.
Ingenuity, commitment, sense of pride...

These are the values that built this country;
They are the values that built this company.

**Ritchie, proud to be a partner
to the American Cattleman since 1921**

www.ritchiefount.com
Proud Sponsor of:



Ritchie
Fresh Water
For Life™

products

VENTILATION, MOISTURE & VAPOR BARRIERS, TRUSSES & COLUMNS



it prevents wind-driven rain from penetrating the material when compressed. The design is universal. MultiVent can be used on any panel profile with rib heights up to 1-1/4 inch. Adhesive is applied to the flat of the 3-foot foam strip for easy field installation. It can be used on angled roof applications, eliminating the need

for special-cut angle closures. The MultiVent10' is a polyester material, 10 foot in length and can be pre-applied to the ridge cap before installation. Available in 1 inch and 1-1/2 inch widths, it also prevents wind-driven rain while allowing air flow.

SFS intec | Circle 115

SFS intec introduces Hip & RidgeVent—a new universal vent product that fits any screw-down metal panel profile 1/2 inch to 1-1/2 inches. This warranted product can be used under any ridge cap with a pitch from 3:12 to 20:12, or used on hip joints. Conveniently packed in two 10-foot long rolls per package, this product provides superior ventilation, prevents insect and snow infiltration, won't scratch panel finish or clog from airborne dust, and will not hold water like foam venting products. Adhesive holds Hip & RidgeVent in place for easy installation. Available in three sizes: 1 inch high x 2 inches wide; 1 inch high x 3 inches wide; and 1-1/2 inches x 3 inches wide.

MOISTURE & VAPOR BARRIERS

Filc d.d. Menges | Circle 178

Dripstop helps fight condensation without insulation. Dripstop has specially-designed air pockets that store condensation and hold it until conditions change and it evaporates back into humidity. Because it arrives at the job site already on the steel, there are no costs for installing insulation, plus it saves time by removing one step of the building process and helps fight corrosion by adding another layer of protection from the corrosive elements in livestock confinement.

TRUSSES & COLUMNS



Rigidply Rafters | Circle 179

Rigidply Rafters has improved the quality of post-frame buildings by manufacturing and distributing the original 100 percent glue-laminated post. By specifying Rigidply posts, you guarantee the labor saving and quality advantages of true GluLam posts. Not

THE SOLUTION TO WIND UPLIFT PROBLEMS

WIND BAR™



- WINDBAR** - NEW PATENTED WINDSTOPPER KEEPS THE FLAT OF THE PANEL FROM UPLIFTING
- WINDBAR** - HELPS METAL ROOF PANELS MEET THE NEW IBC BUILDING CODE REQUIREMENTS
- WINDBAR** - FACTORY TESTED UNDER ASTM E-1592 (call for results)
- WINDBAR** - NO ROOF PENETRATIONS

CALL (800) 711-9724

VISIT OUR WEBSITE AT: WWW.WINDBAR.COM

Circle Reader Service #588

only are GluLam posts lighter, straighter and stronger than solid sawn posts, but they minimize cracking and splitting. When planning your next building project, count on Rigidply Rafters to supply integrity, quality and service with your GluLam posts.



Starwood Rafters | Circle 180

Starwood Rafters' laminated wood products include Lam-Ply Truss, the company's most popular product. It combines plywood with

glulams and dimensional lumber for stronger trusses that can be spaced farther apart. It can be used in many applications.

FOUNDATION PRODUCTS

Levi's Building Components | Circle 112

Uplift Plates from Levi's Building Components are designed to help the post-frame builder save time, money and meet or exceed the post uplift requirements for concreted posts. These inexpensive plates can be field applied with just a framing hammer, eliminating the need for extra tools and time associated with rebar and other uplift technology. They're lightweight, easy to handle and easy to install. They are low cost and stronger than rebar and protect the center of the post by eliminating exposure to the elements, thereby resisting decay.

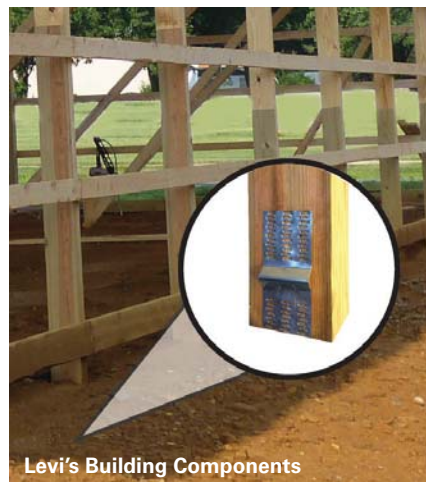

Levi's Building Components

Perma-Column Inc. | Circle 181

Perma-Column precast concrete columns replace treated wood posts in the ground, ensuring a building's foundation will never rot. They are the first product

SHEET METAL FOLDING MACHINES

SINGLE & DOUBLE BENDERS FOR MODERN METAL FORMING!

This patented, unique and cutting edge bending system not only offers flexibility and dramatically reduces material handling but is also capable of bending unique profiles like never before. Features a very user-friendly touch screen with high tech software that is simple and easy to understand! A superior machine at a competitive price!



European-Designed & USA Made!

Variobend USA

The Radiant Floor Heat Solution!



Hershey's the Metal Meister, LLC
Nelson Hershberger & Sons
7405 E Mt. Pleasant Ln.
Claremont, IL 62421

Hitz Halter

- Proven by Unbiased, Real World Testing
- Owner, Shipper, and Installer Friendly
- 4' x 24' Fanfolded Sheets
- Termite & Insect Resistant • Will Never Waterlog

TOLL FREE: (877) 289-3030
PH: (618) 869-2222
FAX: (618) 869-2255

Call Today for More Information and Your Free Brochure on the Hitz Halter and Variobend!



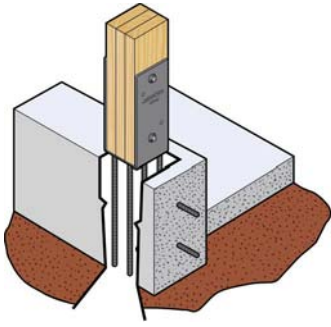

Plasti-Sleeve Post Protection | Circle 182

to combine the economy of post-frame construction with the durability of a concrete foundation. Also available are Sturdi-Wall heavy-duty anchor brackets designed to connect post-frame structures to an existing concrete foundation, and Sturdi-Wall Plus, designed for ultimate strength to connect post-frame structures to a concrete foundation while the concrete is being poured.

With 19 years in production, the original Plasti-Sleeve is a leader in post protection for buildings, offering economical, versatile and easy slide-on installation for 18 different post sizes. Made in the USA from the highest quality black HDPE plastic, Plasti-Sleeve offers unparalleled in-ground durability. Newly patented Plasti-Skirt, an economical protective plastic skirt board cover, is available for 2x8 and 2x6 skirt boards.



Post Protector Inc. | Circle 183

You'll agree that soil-to-wood contact is not a good thing. Wouldn't it be great if there were a simple way to eliminate all soil-to-wood contact in a pole building and keep it affordable? Wouldn't it be even more mind-blowing if it would retain the use of typical post-in-ground construction technique? Consumers would be tickled not having to worry about foundation longevity. Guess what? You're in luck. The Post Protector/Skirt-Board Protector system makes all this reality.

ATTENTION
Stop setting posts the old way!

This product is patent pending

Check out our video at: www.TheBrutPostGrabber.com



- Eliminate Injuries
- Fast, Effortless Post Setting at Last
- Amazing for Setting into Sauna Tube Projects
- Rental Yards

The perfect / effortless way to set posts attached to "Perma Columns"

Ask about our "Round Pole Grabber"
Great for setting poles and grabbing trees and brush

"FREE QUICK CONNECTS WHEN YOU MENTION THIS AD"

Ask for Scott: 208-964-6666 *President/Creator of the "Brut"*

Circle Reader Service #315

EQUIPMENT

The Brut Post Grabber | Circle 184

Never manhandle heavy posts again. The Brut Post Grabber skid steer attachment makes easy work of post placement. This innovative attachment was designed and developed by a post-frame building contractor. The Brut solves problems of safety, physical strain and hole sloughing. And, it's made in the USA.



Marion Manufacturing | Circle 185

Marion Manufacturing adds the value to the metal by designing, fabricating and installing custom manufacturing and production machinery. Marion specializes in metal forming equipment such as roll formers, uncoilers, shears, stackers, etc. Marion Manufacturing also offers

TAMPA, FLORIDA USA
October 14-16, 2015

25th

METALCON

Learn. Network. Explore.

Best Practices in Metal Technology

Peer-to-Peer Education Sessions

Business Tactics for Success

Innovative Metal Products & Services

Hands-on Metal Roofing Challenges



Title Sponsors:



PSMJ Resources, Inc.®



www.metalcon.com

Circle Reader Service #331



Marion Manufacturing



Metal Rollforming Systems



Paint Valley Parts

a full service machine shop and re-tooling/service on other brands of equipment.

Metal Rollforming Systems | Circle 186

Metal Rollforming Systems designs and manufactures industry-leading roll forming equipment and accessories. Its complete in-house design and manufacturing facility allows MRS to price equipment at a very competitive price, making MRS a leader in roll forming equipment manufacturing. MRS' product lines consist of single and double deck roll formers, single- and multi-trim

roll formers, slitters and much more. MRS takes great pride in its customer support both before and after the sale.

Paint Valley Parts | Circle 187

The all new Deluxe Perforator double pass has profiled center dies to hold material and makes a nice straight perforation. All the perforator dies are designed with D2 steel for longer wear life, as well as the ability to sharpen if the need arises. The dual entry guides can be adjusted to run flat strips for trim pieces. This machine can be powered by electric, hydraulics or mechanically.

Aztec Washer Company

Master Flash®

OVERSIZED HOLE IN YOUR ROOF?
AZTEC HAS THE ANSWER...

FIX-A-FLASH MASTER FLASH®

Pipe Range: 0-15"
Extra Large Base: 19-1/2"

PH: (858) - 513-4350 FAX: (858) - 513-4305
www.aztecwasher.com • info@aztecwasher.com

Circle Reader Service #441

Roll Former Corporation | Circle 188



Roll Former Corporation has been in business since 1978. For 37 years it has designed and manufactured machinery for the metal roofing and construction industry. Today Roll Former Corp., offers over 25 standard product pieces of equipment. For the last 27 years the company has been producing custom profile machines, made in the USA.

Semmler Systems | Circle 189

Semmler's Big Red 111 for fabricating wood laminating columns features a new design that contains 10,000 nails in one loading. Special design of in-line equipment best saves plant layout space and requires only one operator for the total system. Total system equipment includes the Big Red fabricator, conveyor system, gusset press, planer with chip collector, bunk-stacking cart with flanged wheels and track. Now available is the finger joint system that features unique finger joint detail. It's available with jib crane, with vacuum lift and scissor lift.

Swenson Shear | Circle 190

The new Snap Table Pro is an all-in-one machine for slitting and hemming standing seam panels up to 60 inches for commer-

160 DOORS & WINDOWS

New One-Piece 800-746-8273

DOORS

AG DOORS
SHOP DOORS
BARN DOORS
AVIATION

Say **YES...** to Strap-Lift Doors
Say **NO** to Cable Lift

HYDRAULIC—OR—BIFOLD
* One-Piece * DOOR STRAP LIFT and auto latch

SCHWEISSDOORS.com

side Straps

Doors built for a lifetime.

- EVERY DOOR BUILT, DELIVERED AND INSTALLED BY LOCAL PROFESSIONALS
- LIFETIME STRUCTURE WARRANTY
- SAFE, STRONG & WEATHERTIGHT
- ZERO MAINTENANCE
- NO LOST HEADROOM
- NEW OR EXISTING BUILDINGS



POWERLIFT

HYDRAULIC DOORS™

855-368-9595 www.PowerLiftDoors.com

DOORBRIM AWNINGS



An economical solution for protecting doors, windows and hardware from Mother Nature. Divert water to keep doorways dry while preventing rust and decay. DOORBRIMS can be easily installed in minutes. MADE IN USA.

DOORBRIM.COM (954) 649-4922

250 MISCELLANEOUS

STONE WAINSCOT PANEL SYSTEM



URESTONE

large, lightweight, durable, realistic

~96" w x 43" h

phone: 314-524-2040
www.urestonepanels.com

250 MISCELLANEOUS

Extrutech FORM™ System



Extrutech FORM™ System brings a bright new 6" thick by 24" inch wide face to stay-in-place concrete form construction by combining standard concrete form methods with the easy-to-clean, sanitary surface that Extrutech panels provide. Perfect for process area walls.

Suspended Ceiling Panels and Doors also Available

NEW PRODUCT

888-818-0118

Epl www.eplastics.com email: info@eplastics.com **USA**

Manufacturing American-Made PVC Panels for 22 Years!

EXTRUTECH PLASTICS, INC.

400 ROLL FORMERS



MARION MANUFACTURING

- Automation Systems
- Metal Construction Rollformers
- Coil Processing
- Forming & Fabrication
- Recondition Existing Machines

WE ADD THE VALUE TO METAL

1-888-865-8740 www.marionmanufacturing.com



MRS METAL ROLLFORMING SYSTEMS

The Affordable Rollforming Equipment Manufacturer

- Single & Double Deck Rollformers
- Trim Rollformers
- *NEW* Patriot Rollforming Line
- Coil Reels
- Precision Cut Slitting Lines
- Sheet Stackers
- Coil Upenders
- Ridge-Cap Press



1.888.284.6794 www.mrsrollform.com

400 ROLL FORMERS



Acu-Form
ROLL FORMING EQUIPMENT

Manufacturer of metal forming equipment, for commercial and residential construction use.

We use D2 tool steel as a standard.

Phone (330) 674-4003 Fax (330) 674-4035

600 TOOLS/EQUIPMENT DISTRIBUTOR

Make Your Own Nail-Lam Column



BIG RED III
Total Fabricating System

Ph: 605-787-4765
Email: jimsemmler1@msn.com
www.semmlerinc.com

Your One Stop Shop



Clark Industries, Inc.
Since 1967 - Monett, Missouri



Considering equipment?
Consider Clark.

- Roof & Floor Truss Presses
- Multi-Head Truss Presses
- Modular Truss Presses
- Shuttle Presses
- Jack Presses
- H.D. Chord Splicers
- Post & Column Machines
- Floor Truss Machines
- Electric Horizontal Stackers
- Electric Peak-up Stackers
- Conveyor Systems
- Custom Machinery

Call us toll free at: 800.743.9727
or visit us on the web at: www.clark-ind.com



cial, industrial and residential job sites. It handles 12- to 24-inch standing seam profiles. Swenson Shear has spent the last year revamping all of its product lines in metal panel preparation equipment for concealed and exposed fastener panels, soffit and siding, and stone coated steel.

Variobend | Circle 191

Variobend Bending Machines provide amazing bending efficiency and precision for large or small metal roofing companies and general sheet metal manufacturers alike. This patented, unique and cutting-edge bending system not only

offers flexibility and dramatically reduces material handling, but is also capable of bending unique profiles like never before. Features a very user-friendly touch screen with high tech software that is simple and easy to understand. A superior machine at a competitive price.

LOCATION:

Keller Bros. Ford automotive detailing facility, Lebanon, Pennsylvania

ARCHITECT:

Arthur Funk and Sons

CONTRACTOR:

Farmerboy Ag

SIZE:

41'x368'x14'

ROOF & WALL PANEL:

Fabral Grand Rib 3 Plus

SNOW GUARDS:

Levi's Snow Defenders 4500 attached with Levi's Fastgrip #14 metal to wood screws

DETAILING SHOP

Levi's Building Components

www.levisbuildingcomponents.com



After years of operating its detailing shop out of several buildings, Keller Bros. Ford in Lebanon, Pennsylvania, decided to consolidate into one building. Completed



in 2015, the new facility features 16 garage bays, each one dedicated to either interior or exterior work. Winters can be challenging in Pennsylvania, so Levi's Snow Defenders 4500 were installed on the metal roof to protect people and their investments from avalanching snows.

► For more product information from LEVI'S BUILDING COMPONENTS, see page 36.



DYNAMIC FASTENER

Everything for the Metal Builder and Roofer

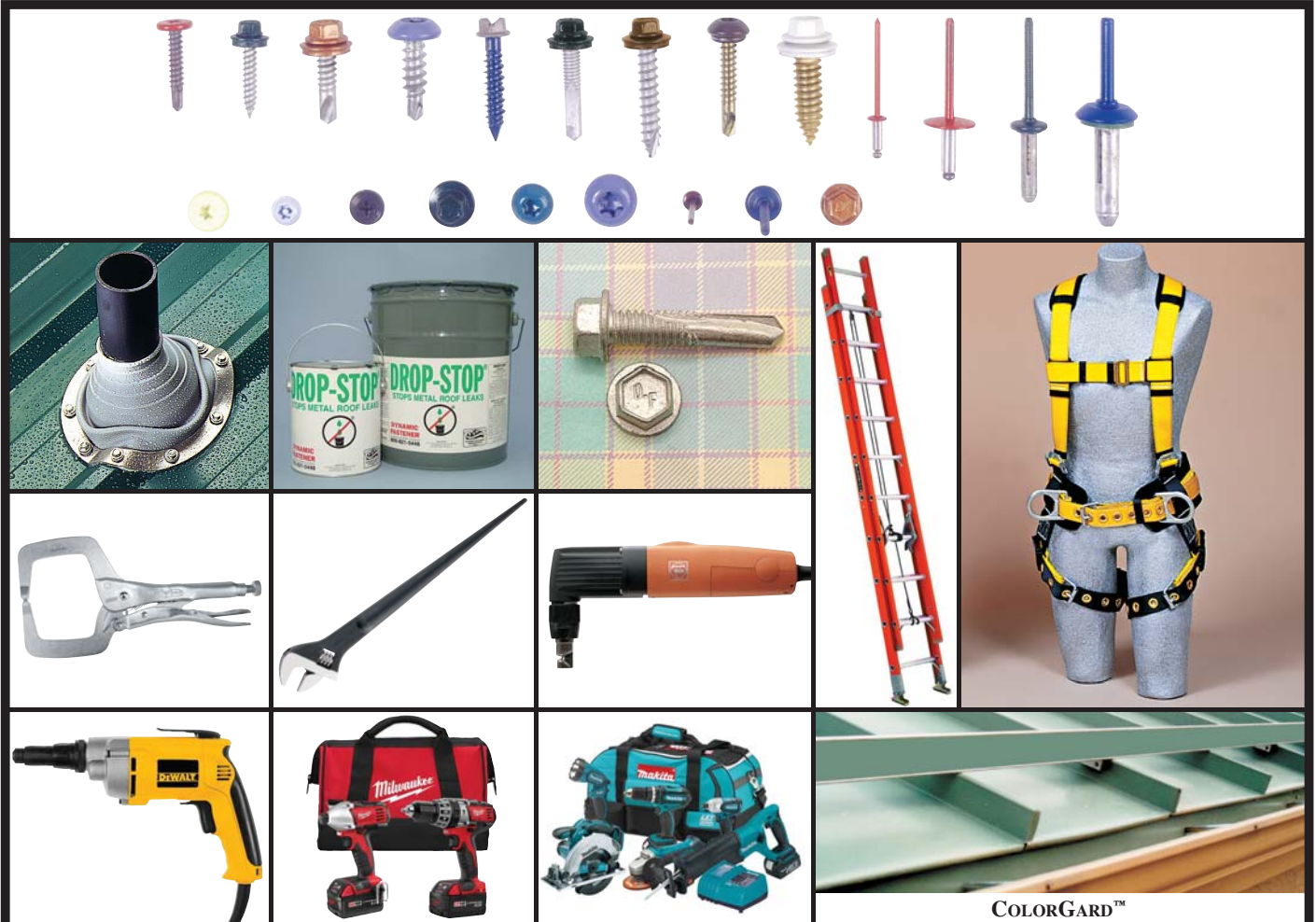

FREE 132 Page Full Color Tool & Fastener Hand Guide provides prices, engineering data & details product offering.

DYNAMIC FASTENER is specifically geared to handle the needs of the Metal Building Contractor. We provide in-house custom color painting of screws and rivets with just a one or two day (days, *NOT* weeks) lead time. **THOUSANDS** of power tools are stocked and sold at the lowest prices. Highest quality, top name brand fasteners are stocked and sold at the lowest prices. Same day shipment on orders received by 4:00 p.m. CST. We are a supplier to the largest metal building manufacturers.

We want to be **YOUR** source for screws, anchors, flashings, colorgard, safety equipment, hand tools, power tools and accessories.

7 warehouses to serve your construction needs for tools and fasteners

(MAIN OFFICE)
Kansas City • Chicago • Houston • Las Vegas • Memphis • St. Louis • St. Paul

CALL 800-821-5448 or FAX 800-844-1199

Call for your Free Full Color 132 Pg. Hand Guide. Better yet, call us for your next tool or fastener requirement. Discover for yourself why your peers enjoy doing business with our company!

Sukup® Steel Buildings



The clear span steel design of Sukup Ag & Industrial Buildings allows them to be adapted to your specific needs. Need room to service a combine or planter? Want room for a shop, storage *and* an office? It can all be done with a Sukup Ag & Industrial Building.

The seams on Sukup Standing Seam Roofs are mechanically-rolled in the field to create a 360° Pittsburgh double-lock seam, so anything you choose to put in your Sukup Building will stay dry and safe. Screw down roofs are also available.

An industrial strength building that's customizable and built to last...

Now THAT'S a Solution™.



Sukup Manufacturing Co. ■ www.sukup.com

641-892-4222 ■ info@sukup.com

1555 255th St. ■ Sheffield, IA USA 50475-0677